

3950X SERIES  
3.50mm HEADERS

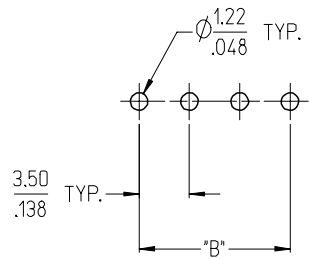

3952X & 3954X SERIES  
5.00mm HEADERS  
5.00mm 10 AMP FIXED

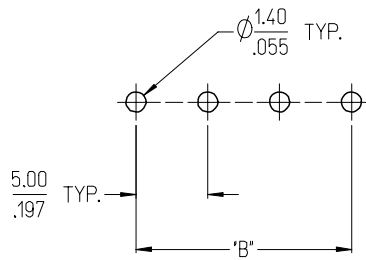

3953X SERIES  
5.08mm HEADERS

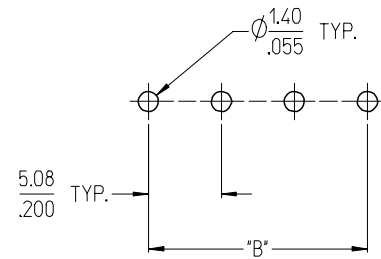

3951X SERIES  
3.81mm HEADERS

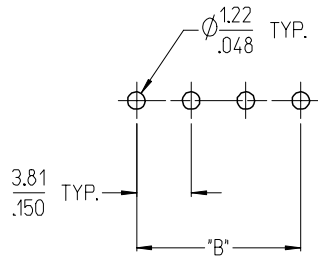

3954X SERIES  
5.00mm 15 AMP FIXED

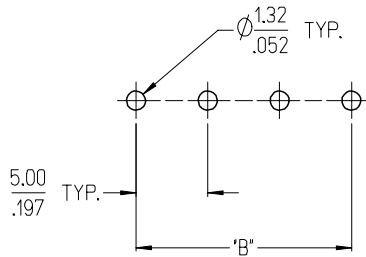

3954X SERIES  
5.08mm 15 AMP FIXED

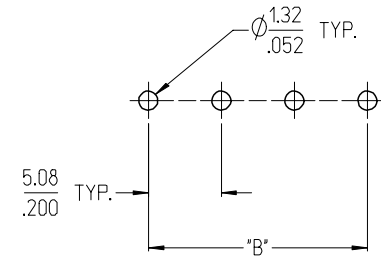

NOTES:

- REFER TO INDIVIDUAL PRODUCT SALES DRAWINGS FOR "B" DIMENSION.
- DOES NOT APPLY TO DUAL LEVEL HEADERS, SERIES 39528 AND 39538.
- TYP. = TYPICAL.

INITIAL RELEASE  
EC NO: ETC2007-0096  
DRWN: CLYORK 2006/10/02  
CHKD: JMACNEIL 2006/10/04  
APPR: JMACNEIL 2006/10/04

QUALITY SYMBOLS  
 =0  
 =0

GENERAL TOLERANCES (UNLESS SPECIFIED)	
	mm
4 PLACES	± .005
3 PLACES	± .005
2 PLACES	± .013
1 PLACE	± .03
ANGULAR ± 2 °	

DRAFT WHERE APPLICABLE  
MUST REMAIN WITHIN DIMENSIONS

DIMENSION STYLE	
MM/IN	
DRAWN BY	DATE
C. YORK	2006/08/25
CHECKED BY	DATE
J. MACNEIL	2006/08/25
APPROVED BY	DATE
J. MACNEIL	2006/08/25
MATERIAL NO.	
--	

SCALE	DESIGN UNITS	THIRD ANGLE PROJECTION
3:1	INCH	
TITLE		
RECOMMENDED PCB LAYOUT FOR ESE TERMINAL BLOCKS		
APPROVED BY		
J. MACNEIL		
DATE		
2006/08/25		
MATERIAL NO.		
SD-39501-002		
SHEET NO.		
1 OF 1		

10 9 8 7 6 5 4 3 2 1

F

E

D

C

B

A

F

E

D

C

B

A

**SPECIFICATIONS:**

**1. Material:**

- (1). Body: PA46
- (2). Pin: Brass
- (3). Threaded insert: Brass

**2. Wire range: N/A**

**3. Electrical rating: 300V, 15A.**

**4. Wire strip length: N/A**

**5. Operating temperature: -40C to +140C.**

**6. Max torque: N/A**

**7. Insulation resistance: DC 500V, 500M.**

**8. Dielectric withstand: AC 2500V for 1 minute.**

**9. Breakdown voltage: 4000V.**

**10. A = (B + 15.24mm)**

**11. B = (N - 1) x P**

**13. C = (B + 10.16mm)**

**12. P (PITCH) = 5.08mm (.200").**

**13. N = Number of positions available 2 through 24.**

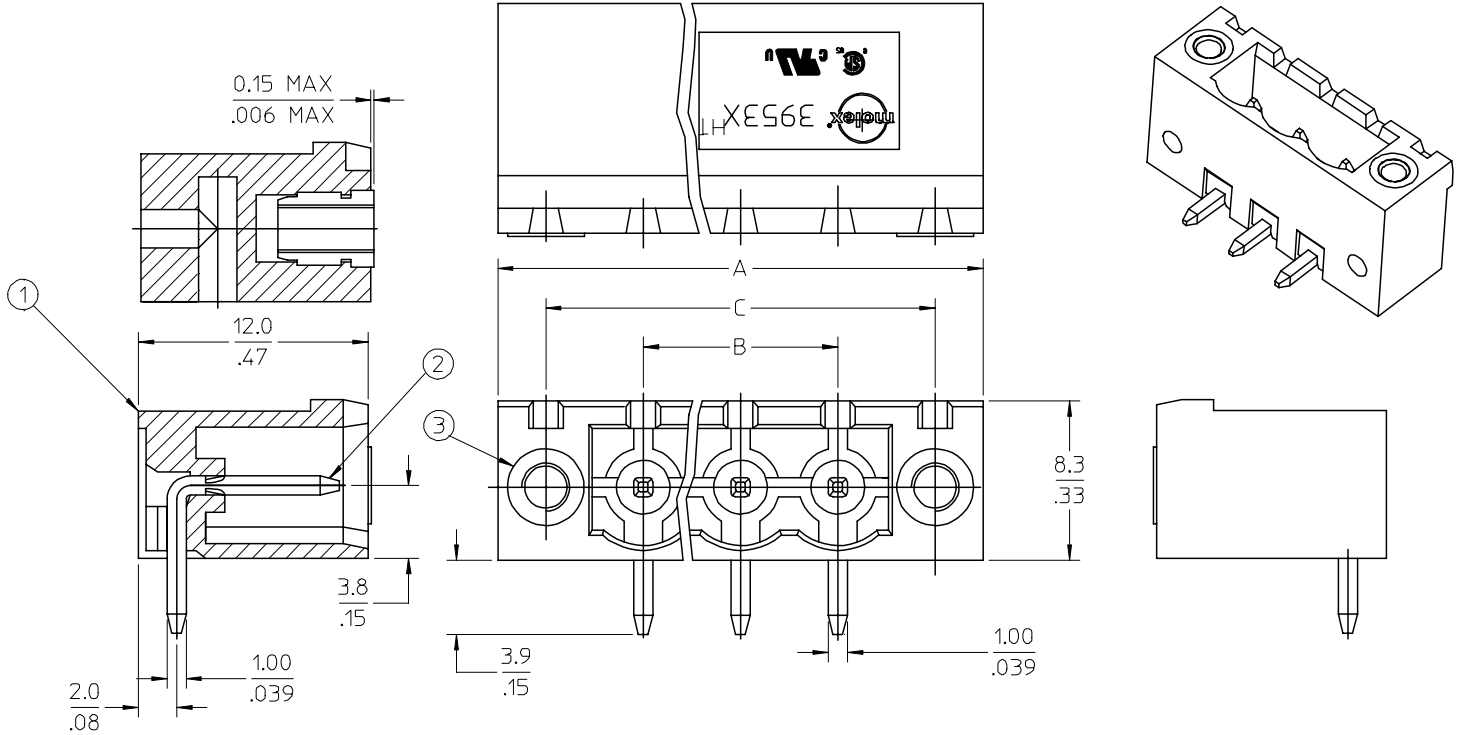

ENTER DESCRIPTION EC NO: NEO2006-0310 DRWNL: LROTHAUS 2006/01/09 CHKD: C YORK 2006/01/09 APPR: J PAMLIK 2006/01/10 DESCRIPTION	QUALITY SYMBOLS	GENERAL TOLERANCES (UNLESS SPECIFIED)	DIMENSION STYLE	SCALE	DESIGN UNITS	THIRD ANGLE PROJECTION															
	▽=0 ▽=0	<table border="1"> <thead> <tr> <th></th> <th>mm</th> <th>INCH</th> </tr> </thead> <tbody> <tr> <td>4 PLACES</td> <td>± ---</td> <td>±.0015</td> </tr> <tr> <td>3 PLACES</td> <td>±0.038</td> <td>±.005</td> </tr> <tr> <td>2 PLACES</td> <td>±0.13</td> <td>±.01</td> </tr> <tr> <td>1 PLACE</td> <td>±0.3</td> <td>± ---</td> </tr> </tbody> </table>		mm	INCH	4 PLACES	± ---	±.0015	3 PLACES	±0.038	±.005	2 PLACES	±0.13	±.01	1 PLACE	±0.3	± ---	MM/IN	4:1	INCH	
		mm	INCH																		
	4 PLACES	± ---	±.0015																		
3 PLACES	±0.038	±.005																			
2 PLACES	±0.13	±.01																			
1 PLACE	±0.3	± ---																			
	ANGULAR ± 2 °	DRAWN BY: LROTHAUS DATE: 12/6/05 CHECKED BY: C. YORK DATE: 01/06/06 APPROVED BY:	TITLE	5.08MM, EURO HEADER, RIGHT ANGLE, HI-TEMP MOUNTING																	
	DRAFT WHERE APPLICABLE MUST REMAIN WITHIN DIMENSIONS	MATERIAL NO. SEE CHART	DOCUMENT NO. SD-39536-001	MOLEX INCORPORATED																	
		SIZE B	THIS DRAWING CONTAINS INFORMATION THAT IS PROPRIETARY TO MOLEX INCORPORATED AND SHOULD NOT BE USED WITHOUT WRITTEN PERMISSION																		

9 8 7 6 5 4 3 2 1

Description	Circuit size	Material Numbers											Dimensional Information							
		Black						Green					Dim. A		Dim. B		Dim. C			
		100% Tin			30 u" Gold			100% Tin			30 u" Gold		mm	inch	mm	inch	mm	inch		
		Printing Options			Printing Options			Printing Options			Printing Options									
None	10A	11A	None	10A	11A	None	10A	11A	None	10A	11A	None	10A	11A	mm	inch	mm	inch	mm	inch
5.08mm, Euro Header, Right Angle, Mounting Ends, High Temp	2	395364002	395364102	395364202	395364502	395364602	395364702	395369002	395369102	395369202	395369502	395369602	395369702	20.32	0.800	5.08	0.200	15.24	0.600	
5.08mm, Euro Header, Right Angle, Mounting Ends, High Temp	3	395364003	395364103	395364203	395364503	395364603	395364703	395369003	395369103	395369203	395369503	395369603	395369703	25.40	1.000	10.16	0.400	20.32	0.800	
5.08mm, Euro Header, Right Angle, Mounting Ends, High Temp	4	395364004	395364104	395364204	395364504	395364604	395364704	395369004	395369104	395369204	395369504	395369604	395369704	30.48	1.200	15.24	0.600	25.40	1.000	
5.08mm, Euro Header, Right Angle, Mounting Ends, High Temp	5	395364005	395364105	395364205	395364505	395364605	395364705	395369005	395369105	395369205	395369505	395369605	395369705	35.56	1.400	20.32	0.800	30.48	1.200	
5.08mm, Euro Header, Right Angle, Mounting Ends, High Temp	6	395364006	395364106	395364206	395364506	395364606	395364706	395369006	395369106	395369206	395369506	395369606	395369706	40.64	1.600	25.40	1.000	35.56	1.400	
5.08mm, Euro Header, Right Angle, Mounting Ends, High Temp	7	395364007	395364107	395364207	395364507	395364607	395364707	395369007	395369107	395369207	395369507	395369607	395369707	45.72	1.800	30.48	1.200	40.64	1.600	
5.08mm, Euro Header, Right Angle, Mounting Ends, High Temp	8	395364008	395364108	395364208	395364508	395364608	395364708	395369008	395369108	395369208	395369508	395369608	395369708	50.80	2.000	35.56	1.400	45.72	1.800	
5.08mm, Euro Header, Right Angle, Mounting Ends, High Temp	9	395364009	395364109	395364209	395364509	395364609	395364709	395369009	395369109	395369209	395369509	395369609	395369709	55.88	2.200	40.64	1.600	50.80	2.000	
5.08mm, Euro Header, Right Angle, Mounting Ends, High Temp	10	395364010	395364110	395364210	395364510	395364610	395364710	395369010	395369110	395369210	395369510	395369610	395369710	60.96	2.400	45.72	1.800	55.88	2.200	
5.08mm, Euro Header, Right Angle, Mounting Ends, High Temp	11	395364011	395364111	395364211	395364511	395364611	395364711	395369011	395369111	395369211	395369511	395369611	395369711	66.04	2.600	50.80	2.000	60.96	2.400	
5.08mm, Euro Header, Right Angle, Mounting Ends, High Temp	12	395364012	395364112	395364212	395364512	395364612	395364712	395369012	395369112	395369212	395369512	395369612	395369712	71.12	2.800	55.88	2.200	66.04	2.600	
5.08mm, Euro Header, Right Angle, Mounting Ends, High Temp	13	395364013	395364113	395364213	395364513	395364613	395364713	395369013	395369113	395369213	395369513	395369613	395369713	76.20	3.000	60.96	2.400	71.12	2.800	
5.08mm, Euro Header, Right Angle, Mounting Ends, High Temp	14	395364014	395364114	395364214	395364514	395364614	395364714	395369014	395369114	395369214	395369514	395369614	395369714	81.28	3.200	66.04	2.600	76.20	3.000	
5.08mm, Euro Header, Right Angle, Mounting Ends, High Temp	15	395364015	395364115	395364215	395364515	395364615	395364715	395369015	395369115	395369215	395369515	395369615	395369715	86.36	3.400	71.12	2.800	81.28	3.200	
5.08mm, Euro Header, Right Angle, Mounting Ends, High Temp	16	395364016	395364116	395364216	395364516	395364616	395364716	395369016	395369116	395369216	395369516	395369616	395369716	91.44	3.600	76.20	3.000	86.36	3.400	
5.08mm, Euro Header, Right Angle, Mounting Ends, High Temp	17	395364017	395364117	395364217	395364517	395364617	395364717	395369017	395369117	395369217	395369517	395369617	395369717	96.52	3.800	81.28	3.200	91.44	3.600	
5.08mm, Euro Header, Right Angle, Mounting Ends, High Temp	18	395364018	395364118	395364218	395364518	395364618	395364718	395369018	395369118	395369218	395369518	395369618	395369718	101.60	4.000	86.36	3.400	96.52	3.800	
5.08mm, Euro Header, Right Angle, Mounting Ends, High Temp	19	395364019	395364119	395364219	395364519	395364619	395364719	395369019	395369119	395369219	395369519	395369619	395369719	106.68	4.200	91.44	3.600	101.60	4.000	
5.08mm, Euro Header, Right Angle, Mounting Ends, High Temp	20	395364020	395364120	395364220	395364520	395364620	395364720	395369020	395369120	395369220	395369520	395369620	395369720	111.76	4.400	96.52	3.800	106.68	4.200	
5.08mm, Euro Header, Right Angle, Mounting Ends, High Temp	21	395364021	395364121	395364221	395364521	395364621	395364721	395369021	395369121	395369221	395369521	395369621	395369721	116.84	4.600	101.60	4.000	111.76	4.400	
5.08mm, Euro Header, Right Angle, Mounting Ends, High Temp	22	395364022	395364122	395364222	395364522	395364622	395364722	395369022	395369122	395369222	395369522	395369622	395369722	121.92	4.800	106.68	4.200	116.84	4.600	
5.08mm, Euro Header, Right Angle, Mounting Ends, High Temp	23	395364023	395364123	395364223	395364523	395364623	395364723	395369023	395369123	395369223	395369523	395369623	395369723	127.00	5.000	111.76	4.400	121.92	4.800	
5.08mm, Euro Header, Right Angle, Mounting Ends, High Temp	24	395364024	395364124	395364224	395364524	395364624	395364724	395369024	395369124	395369224	395369524	395369624	395369724	132.08	5.200	116.84	4.600	127.00	5.000	

SEE SHEET 1 EC NO: NEC2006-0310 DRWNL: LROTHAUS 2006/01/09 CHKD: CYORK 2006/01/09 APPR: J.PAWLIK 2006/01/10	QUALITY SYMBOLS ▽=0 ▽=0	GENERAL TOLERANCES (UNLESS SPECIFIED) mm INCH 4 PLACES ± --- ±.0015 3 PLACES ±0.038 ±.005 2 PLACES ±0.13 ±.01 1 PLACE ±0.3 ± --- ANGULAR ± 2 °	DIMENSION STYLE MM/IN DRAWN BY DATE LROTHAUS 12/16/05 CHECKED BY DATE C. YORK 01/05/06 APPROVED BY DATE	SCALE 4:1 DESIGN UNITS INCH THIRD ANGLE PROJECTION	TITLE 5.08MM, EURO HEADER, RIGHT ANGLE, HI-TEMP MOUNTING	
	MATERIAL NO. SEE CHART	DOCUMENT NO. SD-39536-001	SHEET NO. 2 OF 2			
	DRAFT WHERE APPLICABLE MUST REMAIN WITHIN DIMENSIONS			MOLEX INCORPORATED		
	THIS DRAWING CONTAINS INFORMATION THAT IS PROPRIETARY TO MOLEX INCORPORATED AND SHOULD NOT BE USED WITHOUT WRITTEN PERMISSION					