

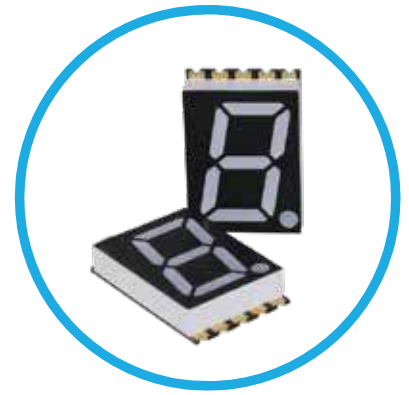

# DSM7T Series

## Thin Surface Mount Single Digit 7-Segment LED Numeric Display



DSM7TA28106T - 0.28" (7.11mm) Digit Height  
Emitting Color: Blue (InGaN)

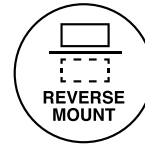
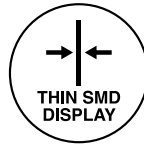

DSM7TA28106T

### Application

- People Movers
- Home Appliances
- Medical Devices
- Industrial Devices
- Automation and Controls
- Light Control
- IoT
- Transportation
- Food Service Appliances

### Key features

- 1-digit seven segment led numeric display
- Includes a decimal point (DP), useful when two or more seven-segment displays are connected to each other to display decimals
- White segments and grey surface
- Substrate: InGaN
- Outer dimensions: 12.0 x 7.40 x 4.00mm
- High light output
- Excellent character appearance
- Quality tested with the highest industry standard
- Side by side mounting allows space saving
- Provides the ability to reduce overall thickness of PCB, with major cost savings
- Available in 3 different digit heights and widths
- Automation-friendly tape and reel
- Technically and mechanically rugged
- Small and light, easy assembly
- Life expectancy: up to 50,000 hours
- Lower power consumption
- Allow top mount and reverse mount design
- Mechanically rugged
- Moisture Sensitive Level (MSL): 2a
- Available in blue, red and pure green
- Polarity: common anode
- Easy mounting on PC boards or sockets
- Low current operation
- Degree of protection IP50 (Dust-Protected)

# Ordering Data

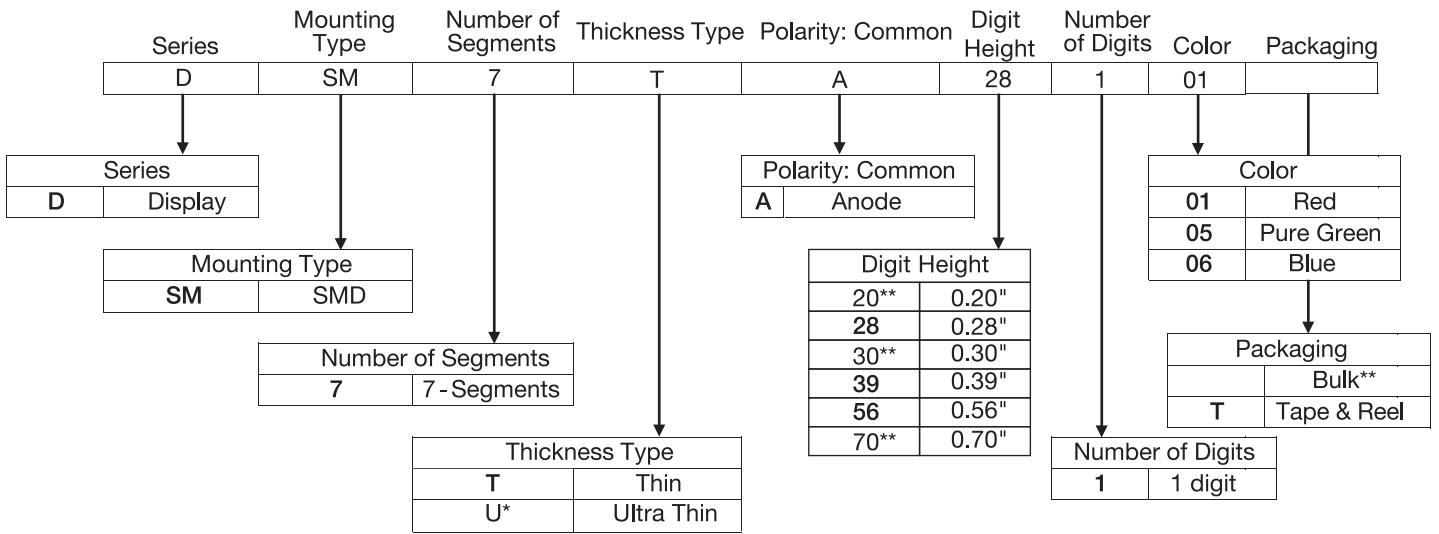

\*Please refer to DSM7U product datasheet for Ultra Thin Version  
 \*\*Only available for DSM7U Version

# Dimensions and Internal Circuit Diagram

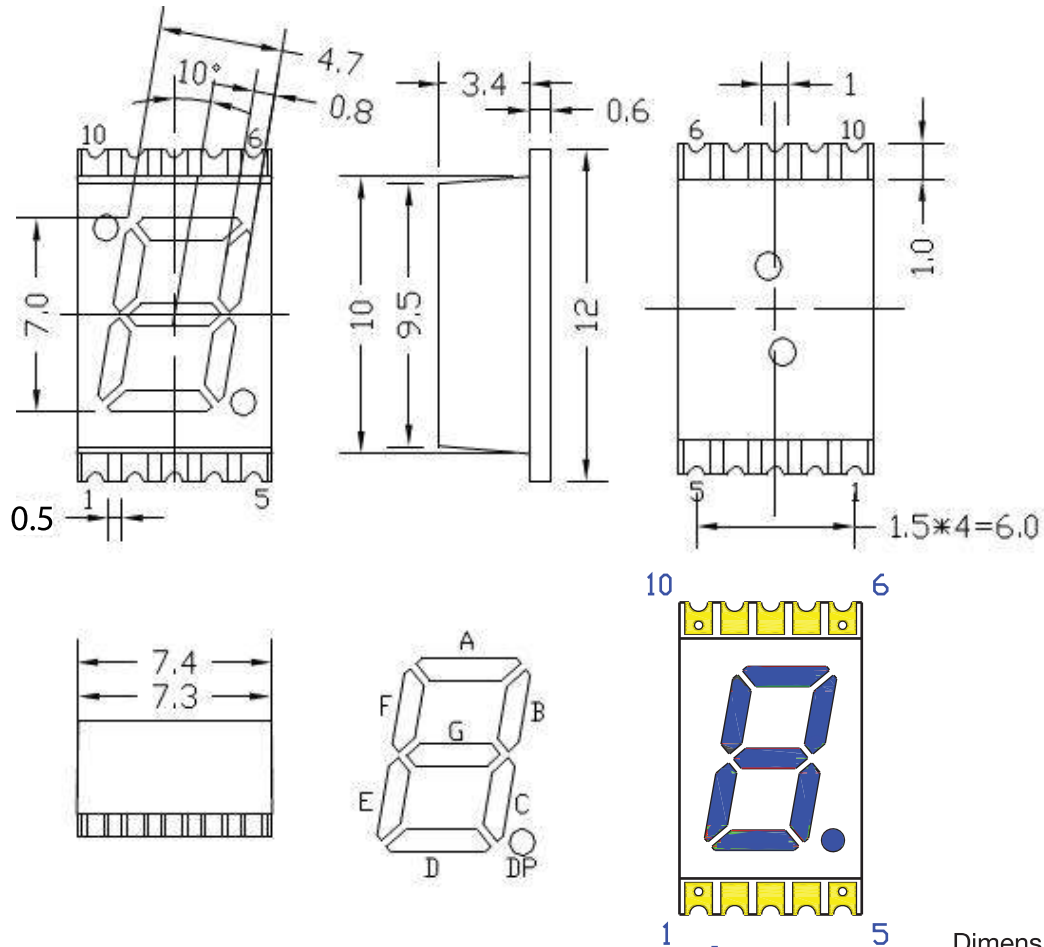

Dimensions in millimeters  
 Tolerance is ±0.25mm unless otherwise noted

## Internal Circuit Diagram

### Pin Connections (Common Anode)

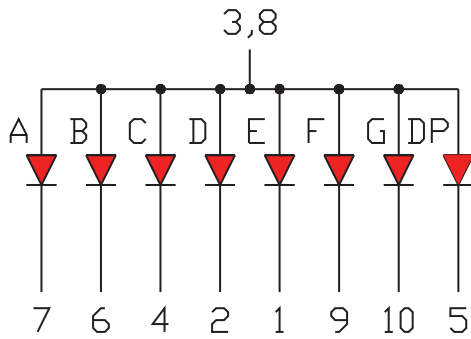

PIN No	Connection
1	CATHODE E
2	CATHODE D
3	COMMON ANODE
4	CATHODE C
5	CATHODE DP
6	CATHODE B
7	CATHODE A
8	COMMON ANODE
9	CATHODE F
10	CATHODE G

## Product Specifications

### Absolute Maximum Ratings while Ta=25°C

Parameter	Minimum (m)	Maximum (M)	Unit
Forward Current $I_F$ /Seg	--	20	mA
Reverse Voltage $V_R$ /Seg	--	5	V
Operating Temperature $T_{OPR}$	-30	+85	°C
Storage Temperature $T_{STG}$	-40	+100	°C
Peak Current $I_{FM}$ /Seg	--	60	mA

(Notice: 1/10th duty cycle, 0.1ms pulse width)

### Electrical-Optical Characteristics while Ta=25°C

Parameter	Condition	Unit	Minimum	Typical	Maximum
Forward Voltage $V_F$ /Seg	IF=20mA	V	2.6	3.1	3.6
Reverse Current $I_R$ /Seg	VR=5V	μA	--	--	50
Wavelength $\lambda_P$	IF=20mA	nm	455	460	465
Full Width at Half Maximum $\Delta\lambda$	IF=20mA	nm	--	15	--
Luminosity $I_V$ /Seg	IF=20mA	mcd	150	210	305
Viewing angle	wide viewing angle				

# Product Specifications

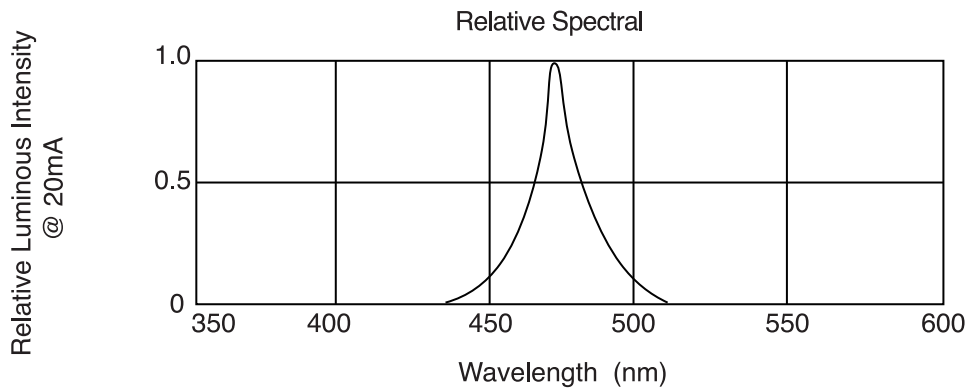

**Forward Current vs. Forward Voltage**

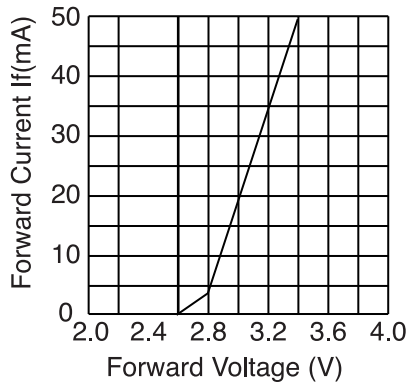

**Relative Luminous Intensity vs. Forward current**

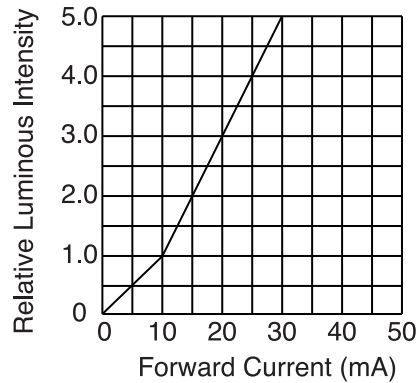

**Forward Current Vs. Temperature**

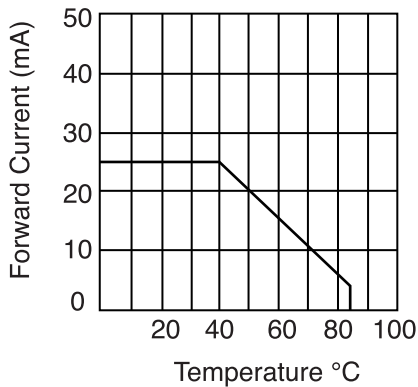

**Luminous Intensity vs. Temperature**

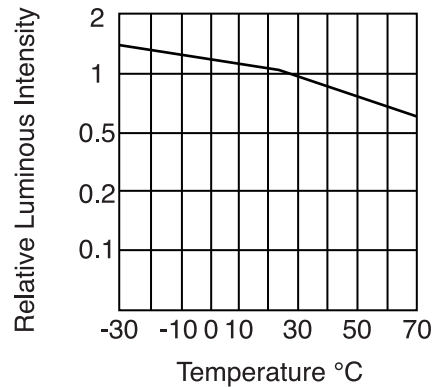

## Circuit Design Notes

- Always use current limit resistors when necessary
- LEDs could be electrically connected in parallel, with each current limiting resistor

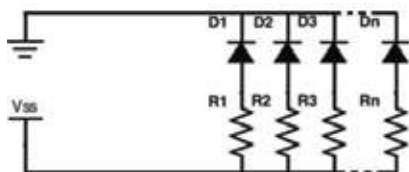

Correct

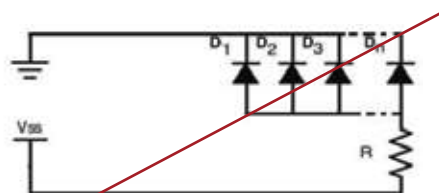

**INCORRECT**

# Recommended Reflow Soldering Profile

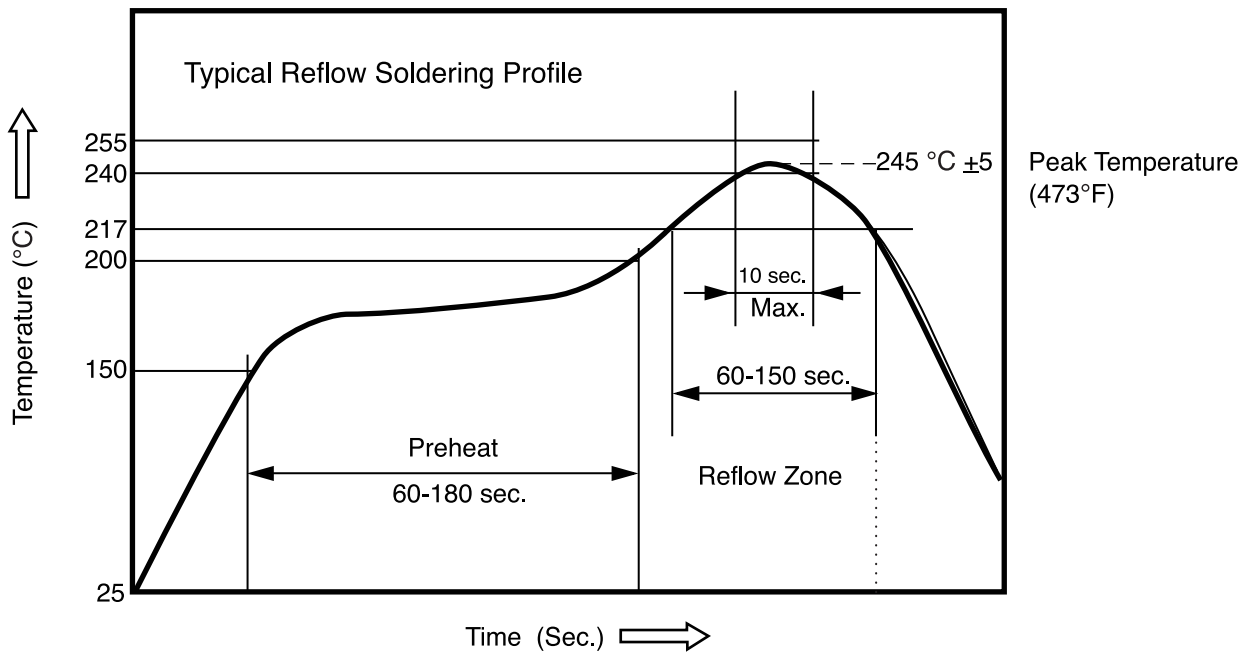

Profile Feature	Typical Parameters
Preheat Temperature Min	150 °C (302°F)
Preheat Temperature Max	200 °C (392°F)
Preheat Time	60 -180 sec.
Reflow Starting Temperature	217 °C (423°F)
Time Spent During Reflow	60 -150 sec.
Reflow Peak Temperature	245 °C (473°F)

- Manual soldering is suggested
  - Use soldering irons of which power is less than 30 Watt.
  - Keep the temperature of soldering irons below 360 °C
  - Only one soldering is allowed on each bonding pad.
  - The maximum time from when a soldering iron comes into contact with the parts that are to be connected until the joint is finished should not exceed three seconds.
  - Perform other procedures after the soldered pad cools down.
- Suggested storage conditions: 25°C +/-10°C (77°F +/-50°F), relative humidity 65% RH +/- 20% RH.

# Tape and Reel Dimensions

Carrier band

Electrostatic Discharge (ESD) Package  
Anti Static Bags Aluminium Moisture Barrier Bag.

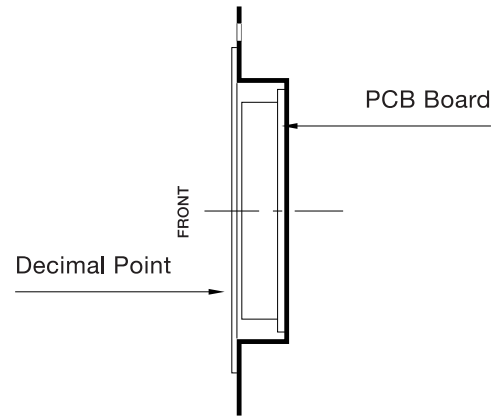
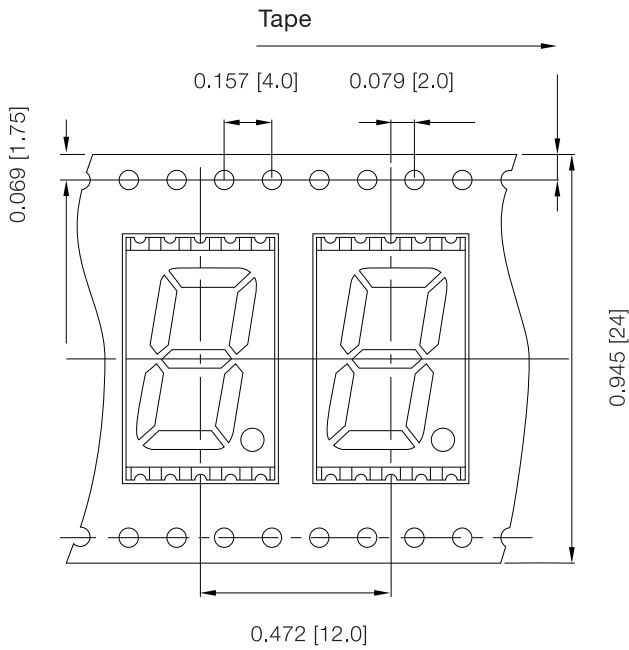

## Reel Dimensions

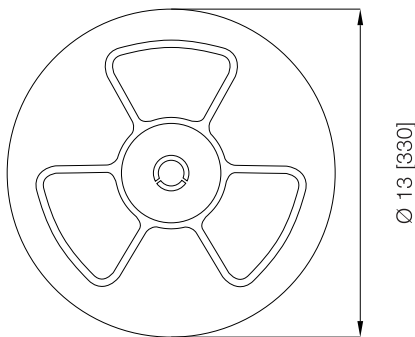

1300PCS/Reel

Direction of the feed

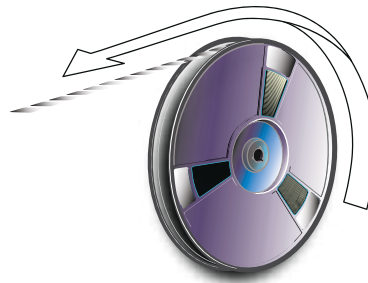

Allow top mount or reverse mount design

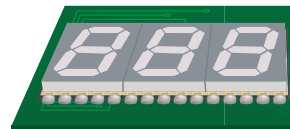

Top Mount



Reverse Mount

Dimensions in inches [millimeters]

## Compliances and Approvals

