



# RF Power Field Effect Transistors

## N-Channel Enhancement-Mode Lateral MOSFETs

Designed for GSM and GSM EDGE base station applications with frequencies from 1800 to 2000 MHz. Suitable for TDMA, CDMA and multicarrier amplifier applications.

### GSM Application

- Typical GSM Performance:  $V_{DD} = 28$  Volts,  $I_{DQ} = 900$  mA,  
 $P_{out} = 100$  Watts,  $f = 1990$  MHz  
Power Gain — 14.5 dB  
Drain Efficiency — 49%

### GSM EDGE Application

- Typical GSM EDGE Performance:  $V_{DD} = 28$  Volts,  $I_{DQ} = 700$  mA,  
 $P_{out} = 40$  Watts Avg., Full Frequency Band (1805-1880 MHz or  
1930-1990 MHz)  
Power Gain — 15 dB  
Drain Efficiency — 35%  
Spectral Regrowth @ 400 kHz Offset = -63 dBc  
Spectral Regrowth @ 600 kHz Offset = -76 dBc  
EVM — 2% rms
- Capable of Handling 5:1 VSWR, @ 28 Vdc, 1990 MHz, 100 Watts CW Output Power

### Features

- Characterized with Series Equivalent Large-Signal Impedance Parameters
- Internally Matched for Ease of Use
- Qualified Up to a Maximum of 32  $V_{DD}$  Operation
- Integrated ESD Protection
- Designed for Lower Memory Effects and Wide Instantaneous Bandwidth Applications
- 225°C Capable Plastic Package
- RoHS Compliant
- In Tape and Reel. R1 Suffix = 500 Units per 44 mm, 13 inch Reel.

**MRF6S18100NR1**  
**MRF6S18100NBR1**

**1805-1990 MHz, 100 W, 28 V**  
**GSM/GSM EDGE**  
**LATERAL N-CHANNEL**  
**RF POWER MOSFETs**

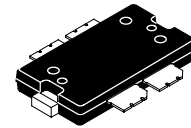

**CASE 1486-03, STYLE 1**  
**TO-270 WB-4**  
**MRF6S18100NR1**

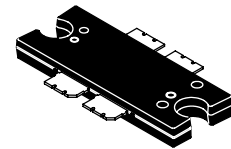

**CASE 1484-04, STYLE 1**  
**TO-272 WB-4**  
**MRF6S18100NBR1**

**Table 1. Maximum Ratings**

Rating	Symbol	Value	Unit
Drain-Source Voltage	$V_{DSS}$	-0.5, +68	Vdc
Gate-Source Voltage	$V_{GS}$	-0.5, +12	Vdc
Storage Temperature Range	$T_{stg}$	-65 to +150	°C
Case Operating Temperature	$T_C$	150	°C
Operating Junction Temperature (1,2)	$T_J$	225	°C

**Table 2. Thermal Characteristics**

Characteristic	Symbol	Value (2,3)	Unit
Thermal Resistance, Junction to Case Case Temperature 80°C, 100 CW Case Temperature 77°C, 40 CW	$R_{\theta JC}$	0.51 0.62	°C/W

1. Continuous use at maximum temperature will affect MTTF.
2. MTTF calculator available at <http://www.freescale.com/rf>. Select Software & Tools/Development Tools/Calculators to access MTTF calculators by product.
3. Refer to AN1955, *Thermal Measurement Methodology of RF Power Amplifiers*. Go to <http://www.freescale.com/rf>. Select Documentation/Application Notes - AN1955.

LIFETIME BUY

LAST ORDER 1 JUL 11 LAST SHIP 30 JUN 12

**Table 3. ESD Protection Characteristics**

Test Methodology	Class
Human Body Model (per JESD22-A114)	1B (Minimum)
Machine Model (per EIA/JESD22-A115)	A (Minimum)
Charge Device Model (per JESD22-C101)	IV (Minimum)

**Table 4. Moisture Sensitivity Level**

Test Methodology	Rating	Package Peak Temperature	Unit
Per JESD22-A113, IPC/JEDEC J-STD-020	3	260	°C

**Table 5. Electrical Characteristics** ( $T_C = 25^\circ\text{C}$  unless otherwise noted)

Characteristic	Symbol	Min	Typ	Max	Unit
----------------	--------	-----	-----	-----	------

**Off Characteristics**

Zero Gate Voltage Drain Leakage Current ( $V_{DS} = 68\text{ Vdc}$ , $V_{GS} = 0\text{ Vdc}$ )	$I_{DSS}$	—	—	10	$\mu\text{Adc}$
Zero Gate Voltage Drain Leakage Current ( $V_{DS} = 28\text{ Vdc}$ , $V_{GS} = 0\text{ Vdc}$ )	$I_{DSS}$	—	—	1	$\mu\text{Adc}$
Gate-Source Leakage Current ( $V_{GS} = 5\text{ Vdc}$ , $V_{DS} = 0\text{ Vdc}$ )	$I_{GSS}$	—	—	500	nAdc

**On Characteristics**

Gate Threshold Voltage ( $V_{DS} = 10\text{ Vdc}$ , $I_D = 330\ \mu\text{Adc}$ )	$V_{GS(th)}$	1.6	2	3	Vdc
Gate Quiescent Voltage ( $V_{DD} = 28\text{ Vdc}$ , $I_D = 900\text{ mAdc}$ , Measured in Functional Test)	$V_{GS(Q)}$	1.5	2.8	3.5	Vdc
Drain-Source On-Voltage ( $V_{GS} = 10\text{ Vdc}$ , $I_D = 3.3\text{ Adc}$ )	$V_{DS(on)}$	—	0.24	—	Vdc

**Dynamic Characteristics<sup>(1)</sup>**

Reverse Transfer Capacitance ( $V_{DS} = 28\text{ Vdc} \pm 30\text{ mV(rms)}$ ac @ 1 MHz, $V_{GS} = 0\text{ Vdc}$ )	$C_{rss}$	—	1.5	—	pF
--	-----------	---	-----	---	----

**Functional Tests** (In Freescale Test Fixture, 50 ohm system)  $V_{DD} = 28\text{ Vdc}$ ,  $P_{out} = 100\text{ W}$ ,  $I_{DQ} = 900\text{ mA}$ ,  $f = 1990\text{ MHz}$ 

Power Gain	$G_{ps}$	13	14.5	16	dB
Drain Efficiency	$\eta_D$	47	49	—	%
Input Return Loss	IRL	—	-12	-9	dB
$P_{out}$ @ 1 dB Compression Point	P1dB	100	110	—	W

**Typical GSM EDGE Performances** (In Freescale GSM EDGE Test Fixture, 50 ohm system)  $V_{DD} = 28\text{ Vdc}$ ,  $I_{DQ} = 700\text{ mA}$ ,  $P_{out} = 40\text{ W Avg.}$ , 1805-1880 MHz or 1930-1990 MHz EDGE Modulation

Power Gain	$G_{ps}$	—	15	—	dB
Drain Efficiency	$\eta_D$	—	35	—	%
Error Vector Magnitude	EVM	—	2	—	% rms
Spectral Regrowth at 400 kHz Offset	SR1	—	-63	—	dBc
Spectral Regrowth at 600 kHz Offset	SR2	—	-76	—	dBc

**Typical CW Performances** (In Freescale GSM Test Fixture, 50 ohm system)  $V_{DD} = 28\text{ Vdc}$ ,  $I_{DQ} = 900\text{ mA}$ ,  $P_{out} = 100\text{ W}$ , 1805-1880 MHz

Power Gain	$G_{ps}$	—	14.5	—	dB
Drain Efficiency	$\eta_D$	—	49	—	%
Input Return Loss	IRL	—	-12	—	dB
$P_{out}$ @ 1 dB Compression Point	P1dB	—	110	—	W

1. Part internally matched both on input and output.

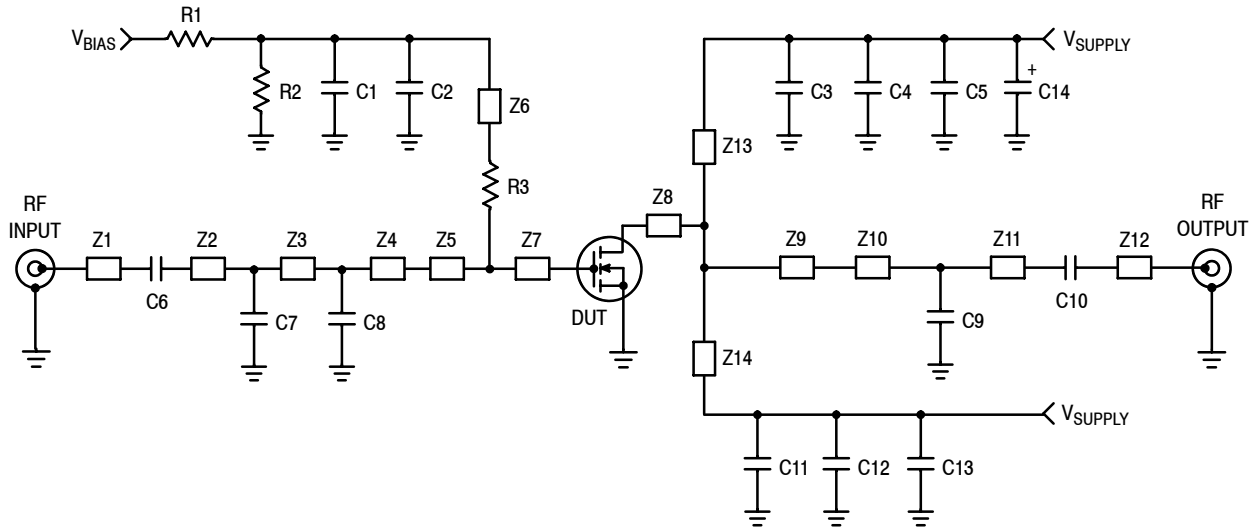

Z1, Z12	0.250" x 0.083" Microstrip	Z9	0.485" x 1.000" Microstrip
Z2*	0.450" x 0.083" Microstrip	Z10*	0.590" x 0.083" Microstrip
Z3*	0.535" x 0.083" Microstrip	Z11*	0.805" x 0.083" Microstrip
Z4*	0.540" x 0.083" Microstrip	Z13, Z14	0.870" x 0.080" Microstrip
Z5	0.365" x 1.000" Microstrip	PCB	Taconic TLX8-0300, 0.030", $\epsilon_r = 2.55$
Z6	1.190" x 0.080" Microstrip		
Z7, Z8	0.115" x 1.000" Microstrip		

\*Variable for tuning.

Figure 1. MRF6S18100NR1(NBR1) Test Circuit Schematic — 1930-1990 MHz

Table 6. MRF6S18100NR1(NBR1) Test Circuit Component Designations and Values — 1930-1990 MHz

Part	Description	Part Number	Manufacturer
C1	100 nF Chip Capacitor	12065C104KAT	AVX
C2, C3, C6, C10, C11	6.8 pF Chip Capacitors	ATC100B6R8BT500XT	ATC
C4, C5, C12, C13	4.7 $\mu$ F Chip Capacitors	C4532X5R1H475MT	TDK
C7	0.3 pF Chip Capacitor	ATC700B0R3BT500XT	ATC
C8	1.3 pF Chip Capacitor	ATC100B1R3BT500XT	ATC
C9	0.5 pF Chip Capacitor	ATC100B0R5BT500XT	ATC
C14	470 $\mu$ F, 63 V Electrolytic Capacitor, Radial	EKME630ELL471MK25S	Multicomp
R1, R2	10 k $\Omega$ , 1/4 W Chip Resistors	CRCW12061002FKEA	Vishay
R3	10 $\Omega$ , 1/4 W Chip Resistor	CRCW120610R0FKEA	Vishay

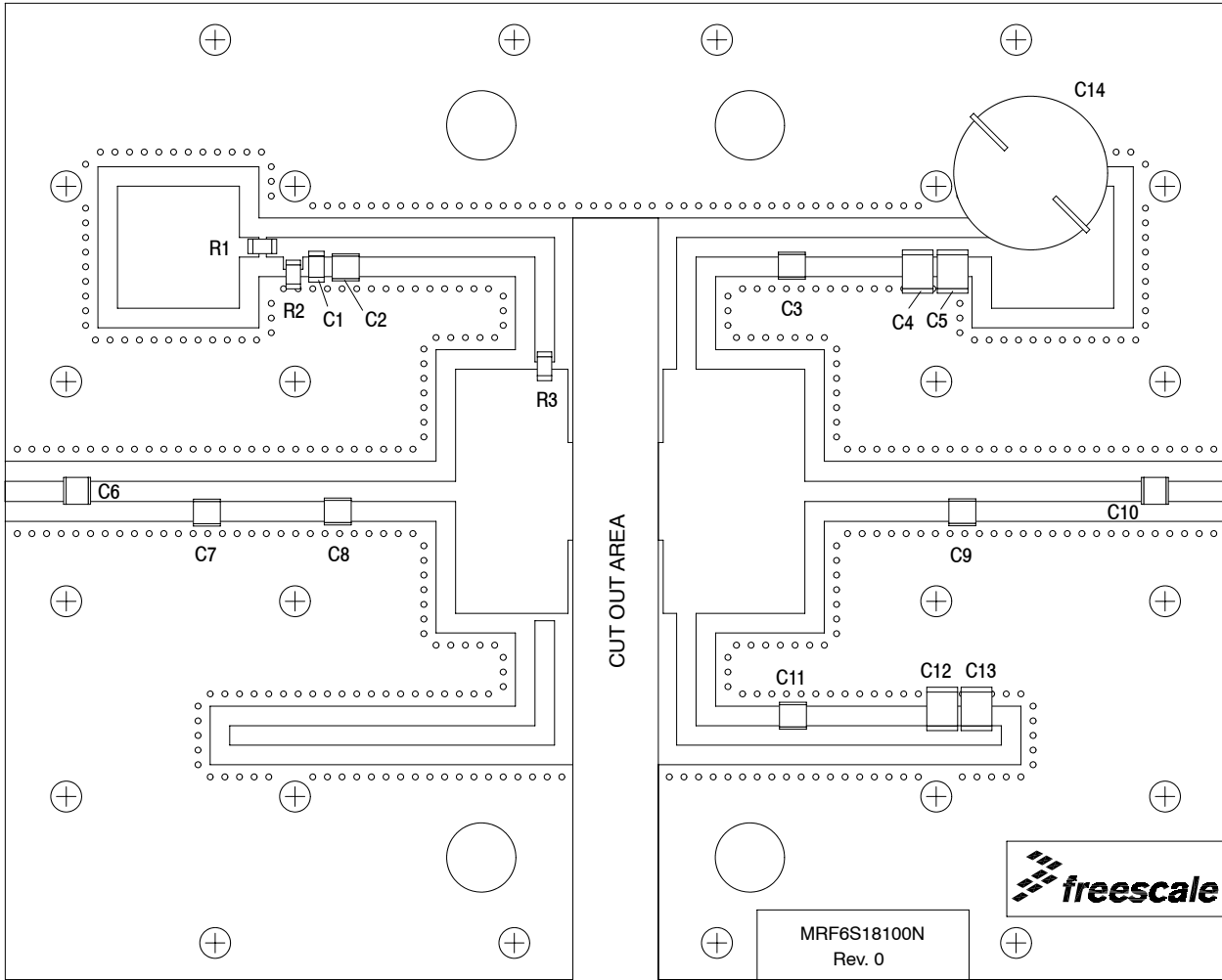

Figure 2. MRF6S18100NR1(NBR1) Test Circuit Component Layout — 1930-1990 MHz

LIFETIME BUY

TYPICAL CHARACTERISTICS — 1930-1990 MHz

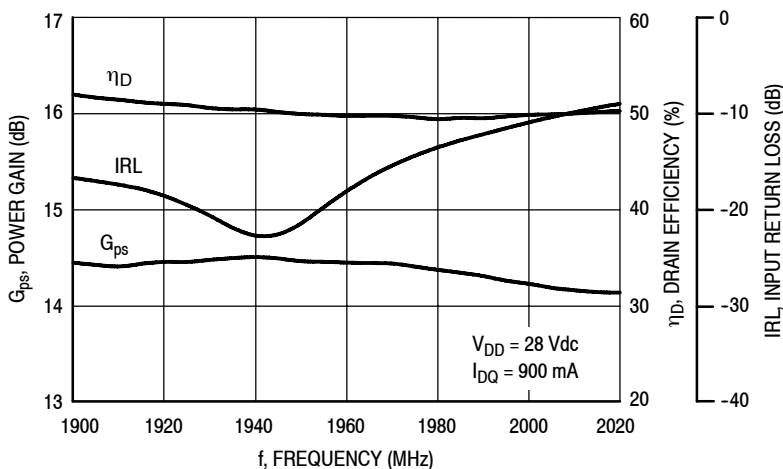

Figure 3. Power Gain, Input Return Loss and Drain Efficiency versus Frequency @  $P_{out} = 100$  Watts

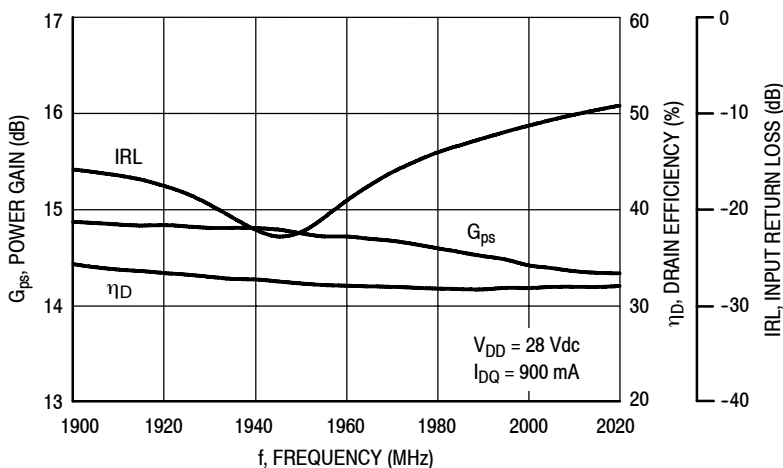

Figure 4. Power Gain, Input Return Loss and Drain Efficiency versus Frequency @  $P_{out} = 40$  Watts

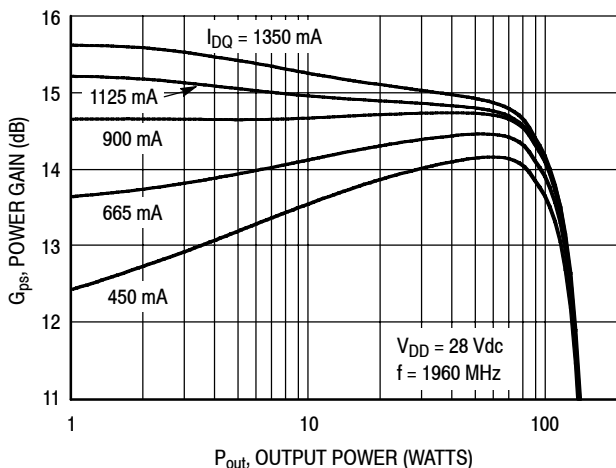

Figure 5. Power Gain versus Output Power

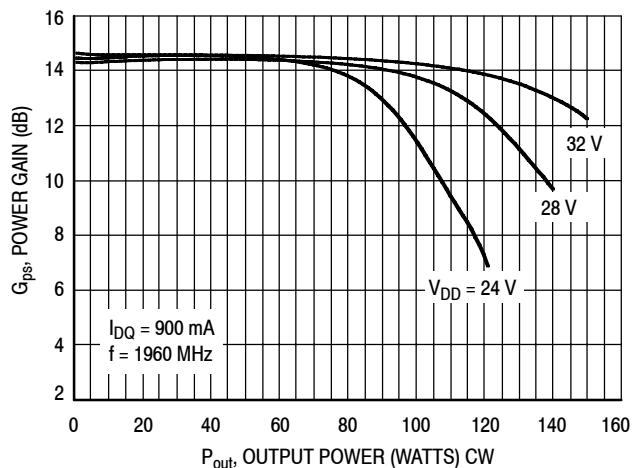

Figure 6. Power Gain versus Output Power

LAST ORDER 1 JUL 11 LAST SHIP 30 JUN 12

MRF6S18100NR1 MRF6S18100NBR1

TYPICAL CHARACTERISTICS — 1930-1990 MHz

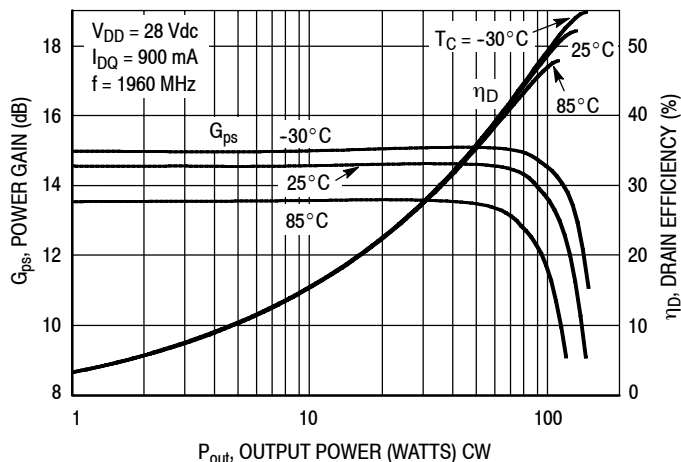

Figure 7. Power Gain and Drain Efficiency versus CW Output Power

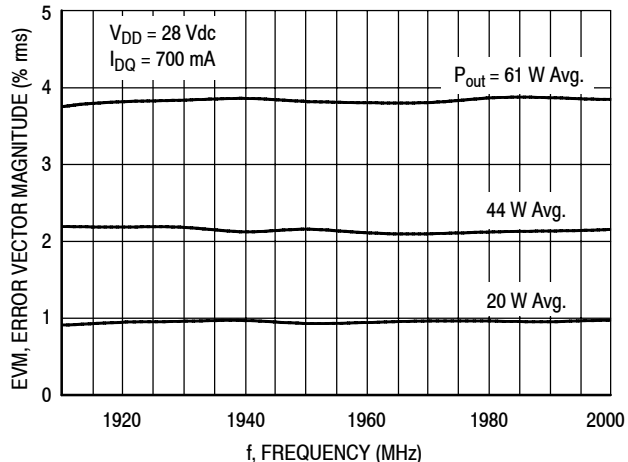

Figure 8. EVM versus Frequency

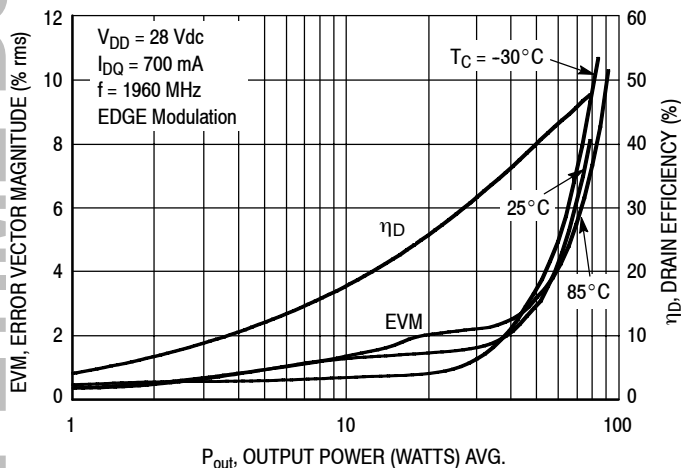

Figure 9. EVM and Drain Efficiency versus Output Power

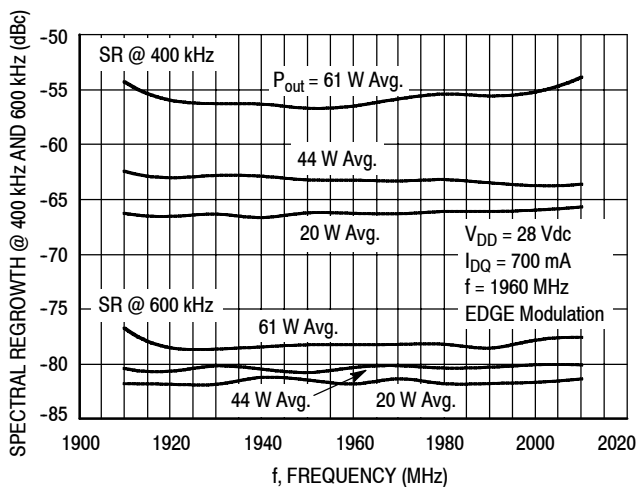

Figure 10. Spectral Regrowth at 400 kHz and 600 kHz versus Frequency

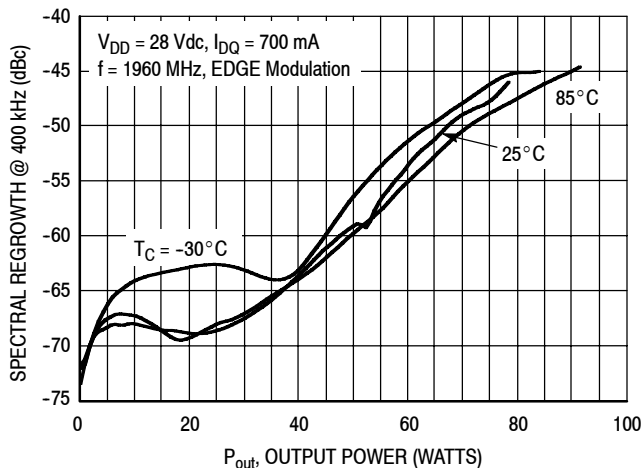

Figure 11. Spectral Regrowth at 400 kHz versus Output Power

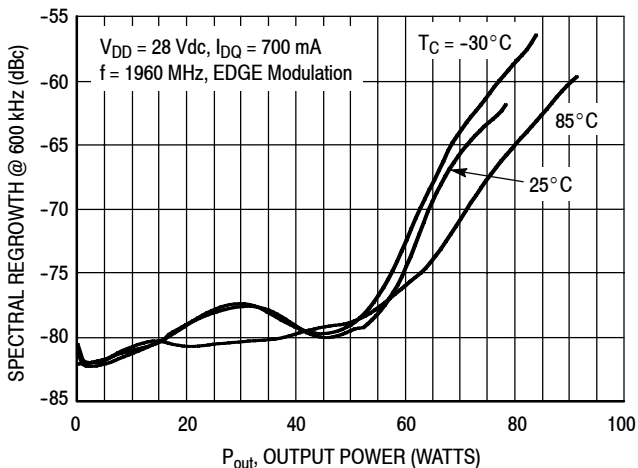
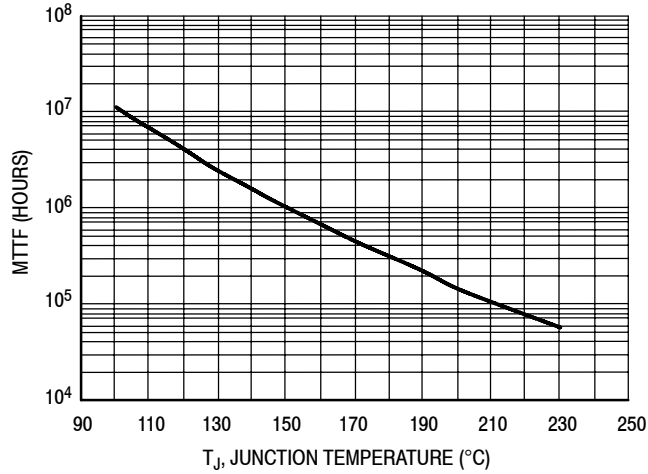

Figure 12. Spectral Regrowth at 600 kHz versus Output Power

LIFETIME BUY

LAST ORDER 1 JUL 11 LAST SHIP 30 JUN 12

TYPICAL CHARACTERISTICS



This above graph displays calculated MTTF in hours when the device is operated at  $V_{DD} = 28$  Vdc,  $P_{out} = 100$  W, and  $\eta_D = 49\%$ .

MTTF calculator available at <http://www.freescale.com/rf>. Select Software & Tools/Development Tools/Calculators to access MTTF calculators by product.

Figure 13. MTTF versus Junction Temperature

GSM TEST SIGNAL

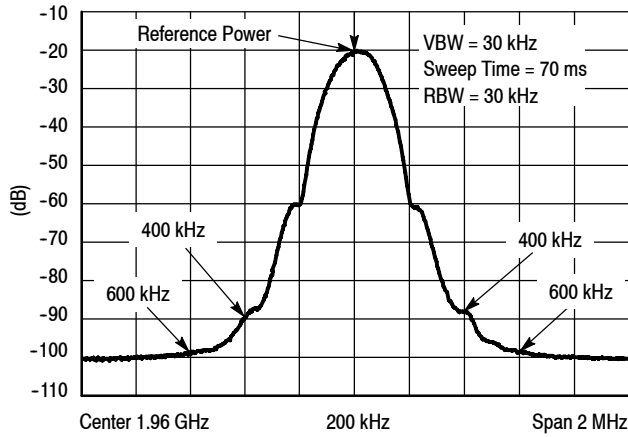
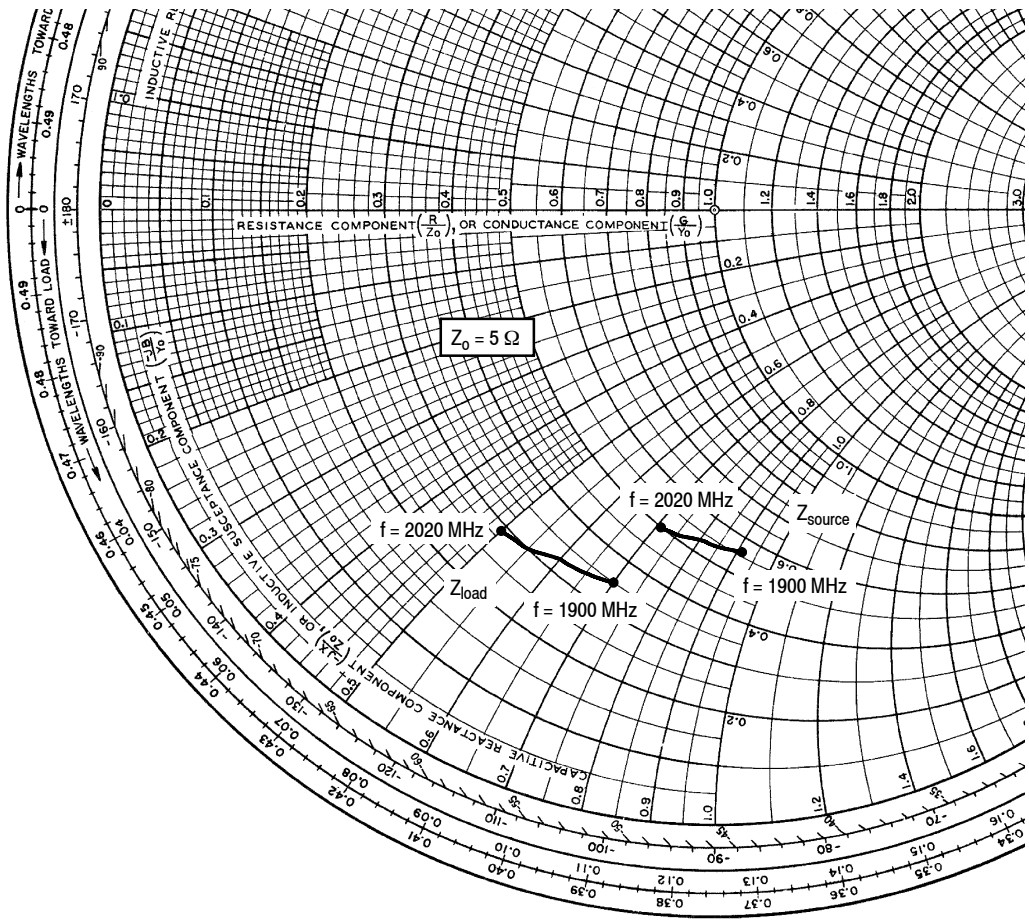

Figure 14. EDGE Spectrum



$V_{DD} = 28 \text{ Vdc}$ ,  $I_{DQ} = 900 \text{ mA}$ ,  $P_{out} = 100 \text{ W}$

f MHz	$Z_{source}$ $\Omega$	$Z_{load}$ $\Omega$
1900	$2.80 - j4.53$	$1.75 - j3.52$
1930	$2.71 - j4.27$	$1.67 - j3.25$
1960	$2.63 - j4.03$	$1.59 - j2.99$
1990	$2.56 - j3.79$	$1.52 - j2.74$
2020	$2.51 - j3.57$	$1.47 - j2.51$

$Z_{source}$  = Test circuit impedance as measured from gate to ground.

$Z_{load}$  = Test circuit impedance as measured from drain to ground.

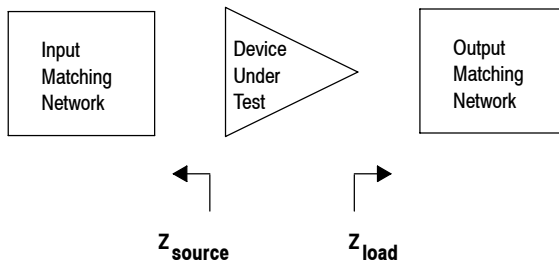
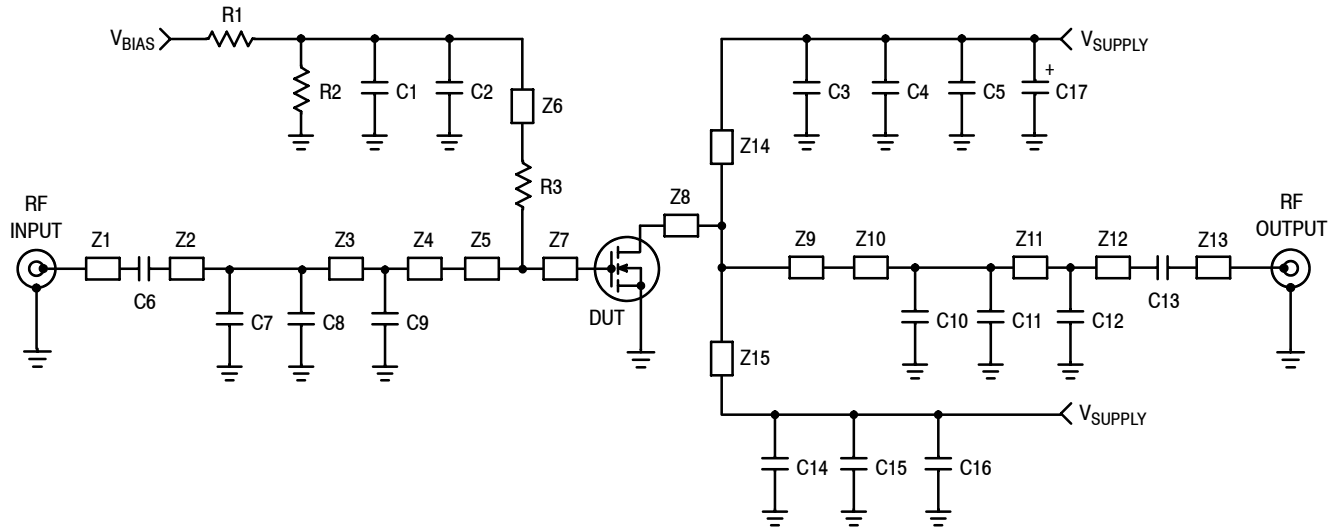

Figure 15. Series Equivalent Source and Load Impedance — 1930-1990 MHz





Z1, Z13	0.250" x 0.083" Microstrip	Z9	0.485" x 1.000" Microstrip
Z2*	0.620" x 0.083" Microstrip	Z10*	0.080" x 0.083" Microstrip
Z3*	0.715" x 0.083" Microstrip	Z11*	0.340" x 0.083" Microstrip
Z4*	0.190" x 0.083" Microstrip	Z12*	0.975" x 0.083" Microstrip
Z5	0.365" x 1.000" Microstrip	Z14, Z15	0.960" x 0.080" Microstrip
Z6	1.190" x 0.080" Microstrip	PCB	Taconic TLX8-0300, 0.030", $\epsilon_r = 2.55$
Z7, Z8	0.115" x 1.000" Microstrip		*Variable for tuning.

Figure 16. MRF6S18100NR1(NBR1) Test Circuit Schematic — 1805-1880 MHz

Table 7. MRF6S18100NR1(NBR1) Test Circuit Component Designations and Values — 1805-1880 MHz

Part	Description	Part Number	Manufacturer
C1	100 nF Chip Capacitor	12065C104KAT	AVX
C2, C3, C6, C13, C14	8.2 pF Chip Capacitors	ATC100B8R2BT500XT	ATC
C4, C5, C15, C16	4.7 $\mu$ F Chip Capacitors	C4532X5R1H475MT	TDK
C7, C8, C11, C12	0.2 pF Chip Capacitors	ATC700B0R2BT500XT	ATC
C9	1 pF Chip Capacitor	ATC100B1R0BT500XT	ATC
C10	0.5 pF Chip Capacitor	ATC100B0R5BT500XT	ATC
C17	470 $\mu$ F, 63 V Electrolytic Capacitor, Radial	EKME630ELL471MK25S	Multicomp
R1, R2	10 k $\Omega$ , 1/4 W Chip Resistors	CRCW12061002FKEA	Vishay
R3	10 $\Omega$ , 1/4 W Chip Resistor	CRCW120610R0FKEA	Vishay

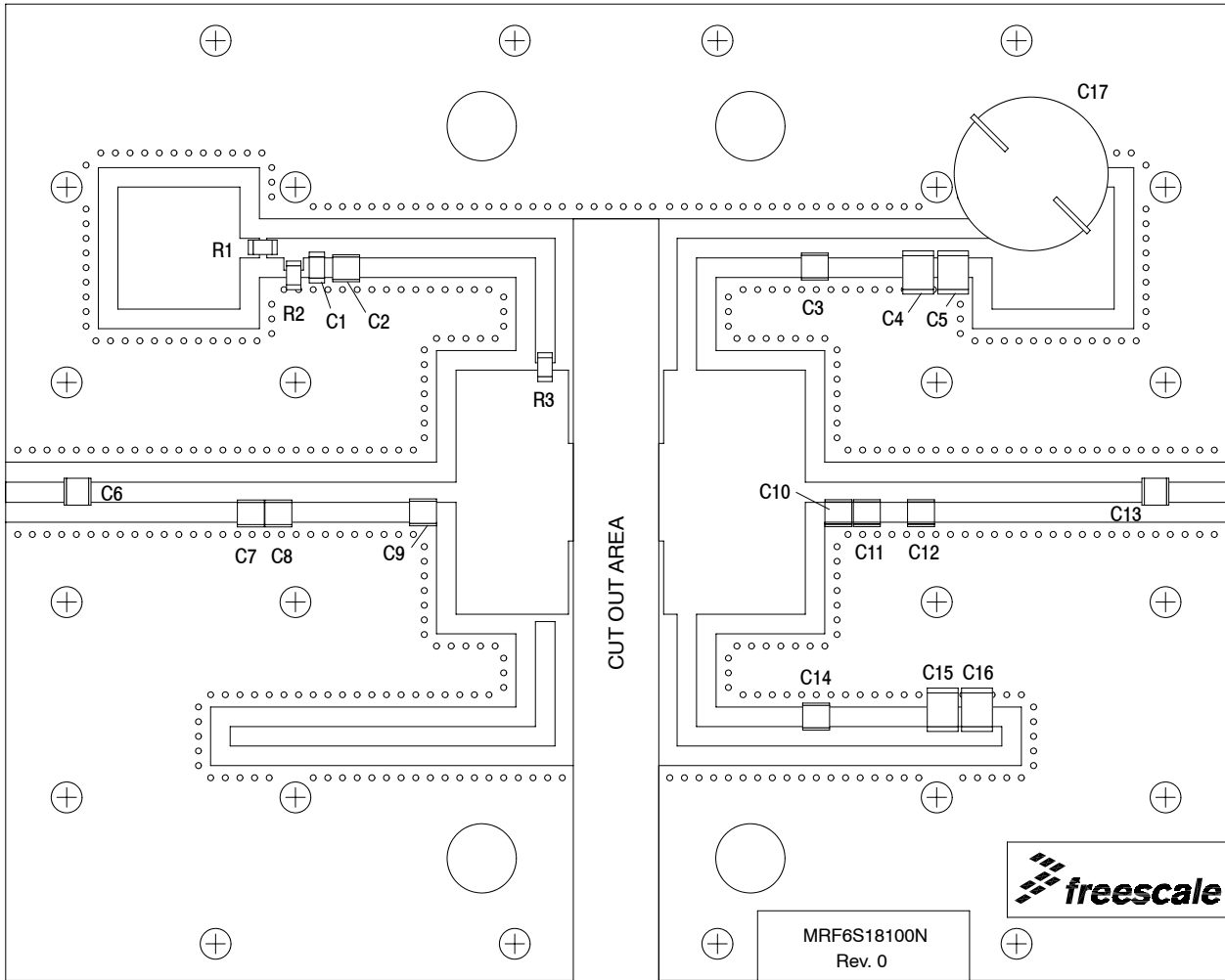

Figure 17. MRF6S18100NR1(NBR1) Test Circuit Component Layout — 1805-1880 MHz

TYPICAL CHARACTERISTICS — 1805-1880 MHz

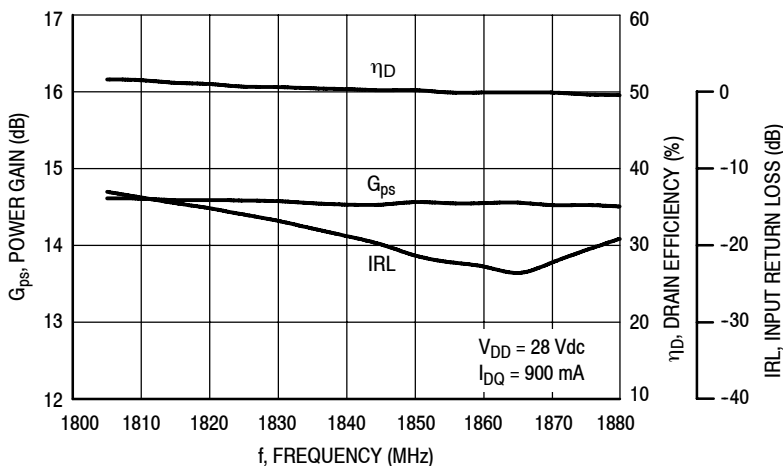

Figure 18. Power Gain, Input Return Loss and Drain Efficiency versus Frequency @  $P_{out} = 100$  Watts

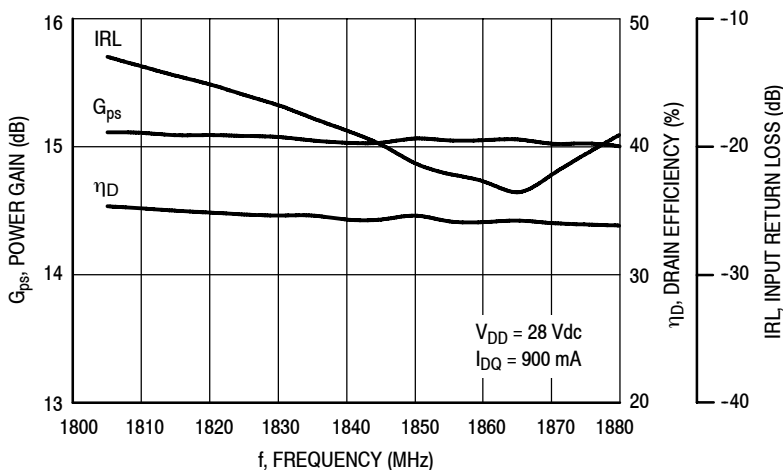

Figure 19. Power Gain, Input Return Loss and Drain Efficiency versus Frequency @  $P_{out} = 40$  Watts

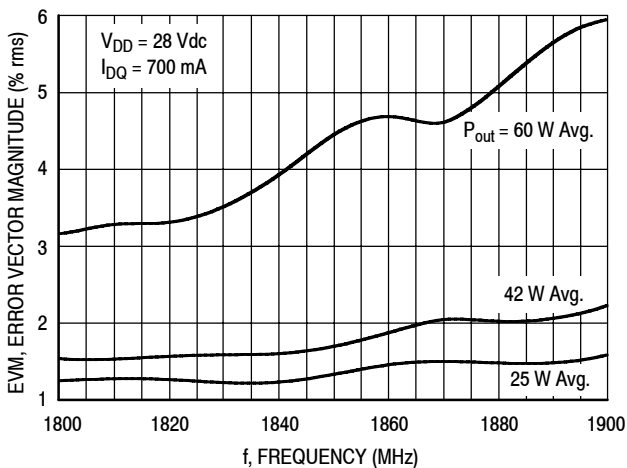

Figure 20. EVM versus Frequency

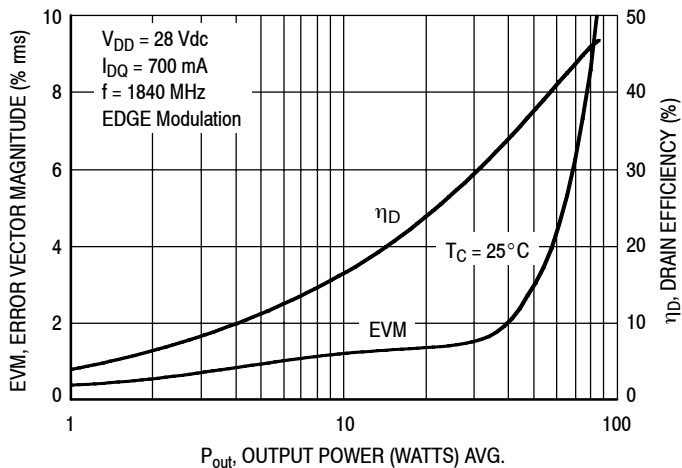

Figure 21. EVM and Drain Efficiency versus Output Power

TYPICAL CHARACTERISTICS — 1805-1880 MHz

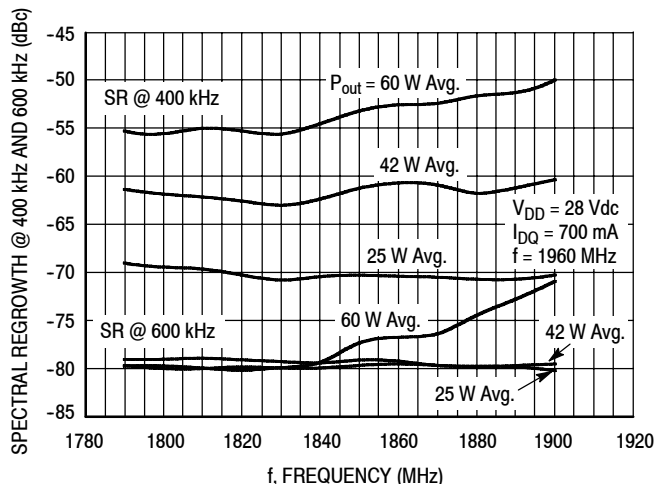

Figure 22. Spectral Regrowth at 400 kHz and 600 kHz versus Frequency

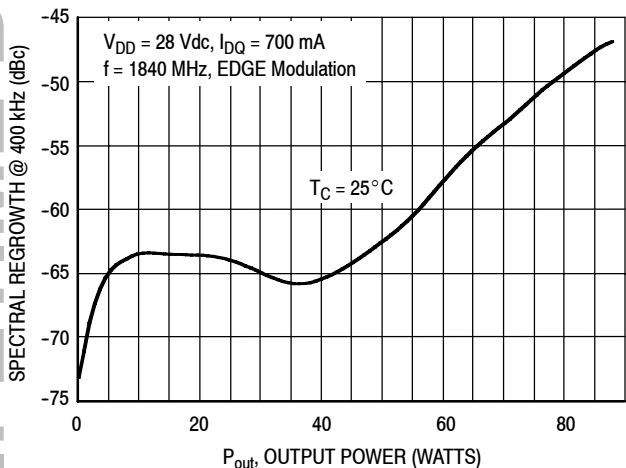

Figure 23. Spectral Regrowth at 400 kHz versus Output Power

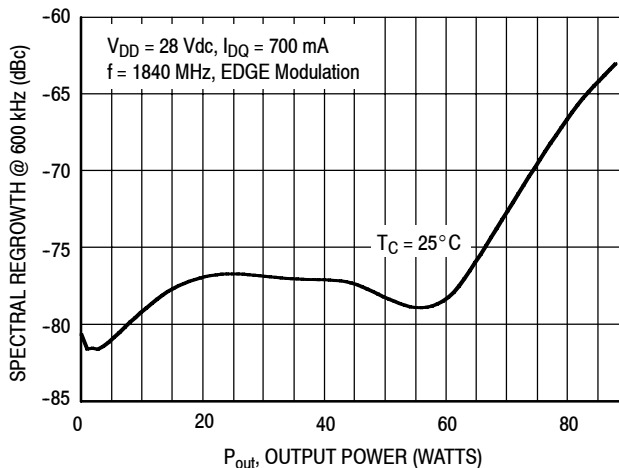
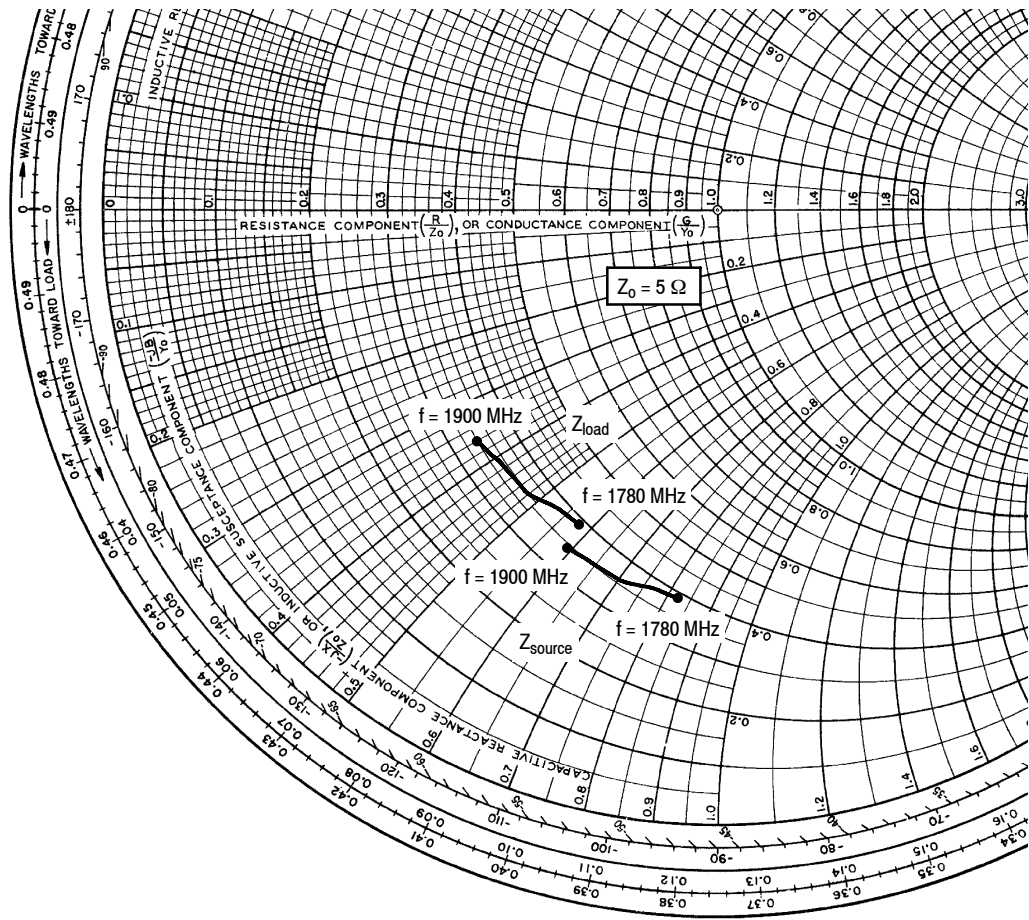

Figure 24. Spectral Regrowth at 600 kHz versus Output Power

LIFETIME BUY

LAST ORDER 1 JUL 11 LAST SHIP 30 JUN 12



$V_{DD} = 28 \text{ Vdc}$ ,  $I_{DQ} = 900 \text{ mA}$ ,  $P_{out} = 100 \text{ W}$

f MHz	Z <sub>source</sub> Ω	Z <sub>load</sub> Ω
1780	1.96 - j4.09	1.94 - j2.90
1804	1.90 - j3.86	1.88 - j2.67
1840	1.82 - j3.53	1.80 - j2.42
1880	1.76 - j3.16	1.73 - j1.99
1900	1.72 - j2.97	1.70 - j1.82

Z<sub>source</sub> = Test circuit impedance as measured from gate to ground.

Z<sub>load</sub> = Test circuit impedance as measured from drain to ground.

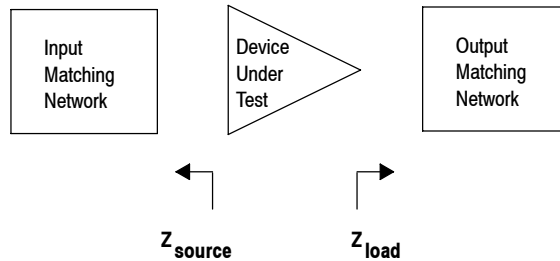
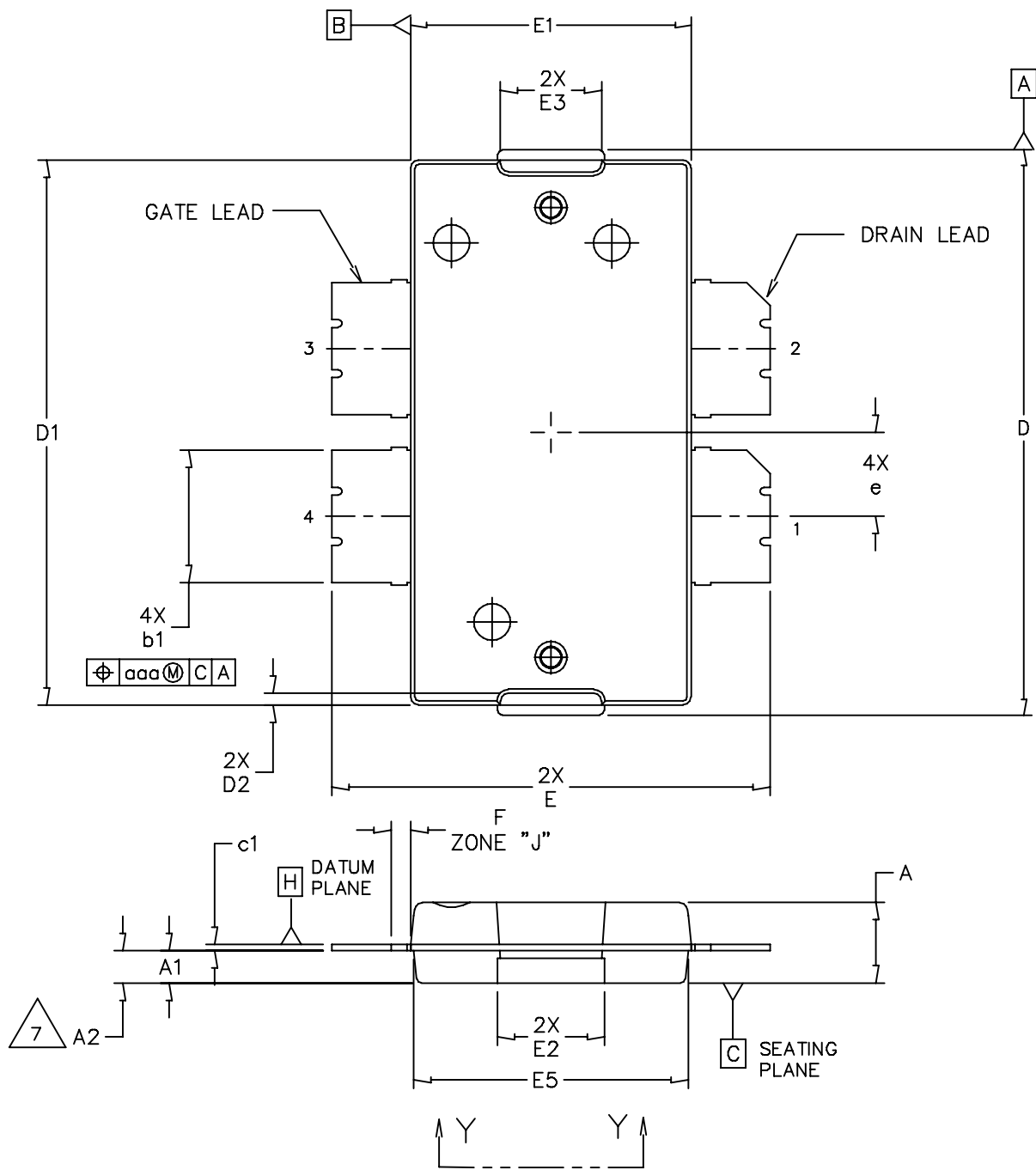
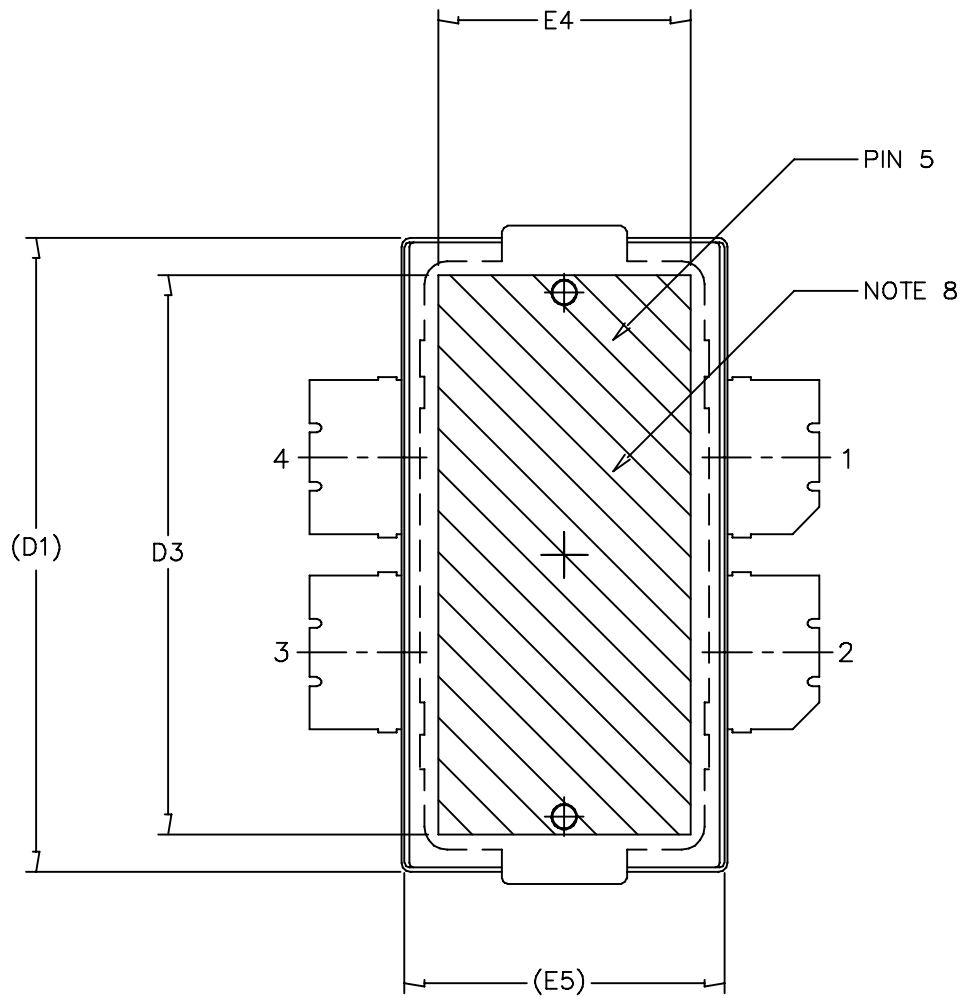

Figure 25. Series Equivalent Source and Load Impedance — 1805-1880 MHz

### PACKAGE DIMENSIONS



© FREESCALE SEMICONDUCTOR, INC. ALL RIGHTS RESERVED.		MECHANICAL OUTLINE	PRINT VERSION NOT TO SCALE
TITLE: TO-270 4 LEAD, WIDE BODY		DOCUMENT NO: 98ASA10577D	REV: D
		CASE NUMBER: 1486-03	13 AUG 2007
		STANDARD: NON-JEDEC	



© FREESCALE SEMICONDUCTOR, INC. ALL RIGHTS RESERVED.	MECHANICAL OUTLINE	PRINT VERSION NOT TO SCALE	
TITLE: TO-270 4 LEAD, WIDE BODY		DOCUMENT NO: 98ASA10577D	REV: D
		CASE NUMBER: 1486-03	13 AUG 2007
		STANDARD: NON-JEDEC	

MRF6S18100NR1 MRF6S18100NBR1

NOTES:

1. CONTROLLING DIMENSION: INCH
2. INTERPRET DIMENSIONS AND TOLERANCES PER ASME Y14.5M-1994.
3. DATUM PLANE -H- IS LOCATED AT THE TOP OF LEAD AND IS COINCIDENT WITH THE LEAD WHERE THE LEAD EXITS THE PLASTIC BODY AT THE TOP OF THE PARTING LINE.
4. DIMENSIONS "D" AND "E1" DO NOT INCLUDE MOLD PROTRUSION. ALLOWABLE PROTRUSION IS .006 PER SIDE. DIMENSIONS "D" AND "E1" DO INCLUDE MOLD MISMATCH AND ARE DETERMINED AT DATUM PLANE -H-.
5. DIMENSIONS "b1" DOES NOT INCLUDE DAMBAR PROTRUSION. ALLOWABLE DAMBAR PROTRUSION SHALL BE .005 TOTAL IN EXCESS OF THE "b1" DIMENSION AT MAXIMUM MATERIAL CONDITION.
6. DATUMS -A- AND -B- TO BE DETERMINED AT DATUM PLANE -H-.
7. DIMENSION A2 APPLIES WITHIN ZONE "J" ONLY.
8. HATCHING REPRESENTS THE EXPOSED AREA OF THE HEAT SLUG.

STYLE 1:

PIN 1 - DRAIN      PIN 2 - DRAIN  
 PIN 3 - GATE      PIN 4 - GATE  
 PIN 5 - SOURCE

DIM	INCH		MILLIMETER		DIM	INCH		MILLIMETER	
	MIN	MAX	MIN	MAX		MIN	MAX	MIN	MAX
A	.100	.104	2.54	2.64	F	.025 BSC		0.64 BSC	
A1	.039	.043	0.99	1.09	b1	.164	.170	4.17	4.32
A2	.040	.042	1.02	1.07	c1	.007	.011	.18	.28
D	.712	.720	18.08	18.29	e	.106 BSC		2.69 BSC	
D1	.688	.692	17.48	17.58	aaa	.004		.10	
D2	.011	.019	0.28	0.48					
D3	.600	---	15.24	---					
E	.551	.559	14	14.2					
E1	.353	.357	8.97	9.07					
E2	.132	.140	3.35	3.56					
E3	.124	.132	3.15	3.35					
E4	.270	---	6.86	---					
E5	.346	.350	8.79	8.89					

© FREESCALE SEMICONDUCTOR, INC. ALL RIGHTS RESERVED.		MECHANICAL OUTLINE		PRINT VERSION NOT TO SCALE	
TITLE:  TO-270 4 LEAD WIDE BODY		DOCUMENT NO: 98ASA10577D		REV: D	
		CASE NUMBER: 1486-03		13 AUG 2007	
		STANDARD: NON-JEDEC			



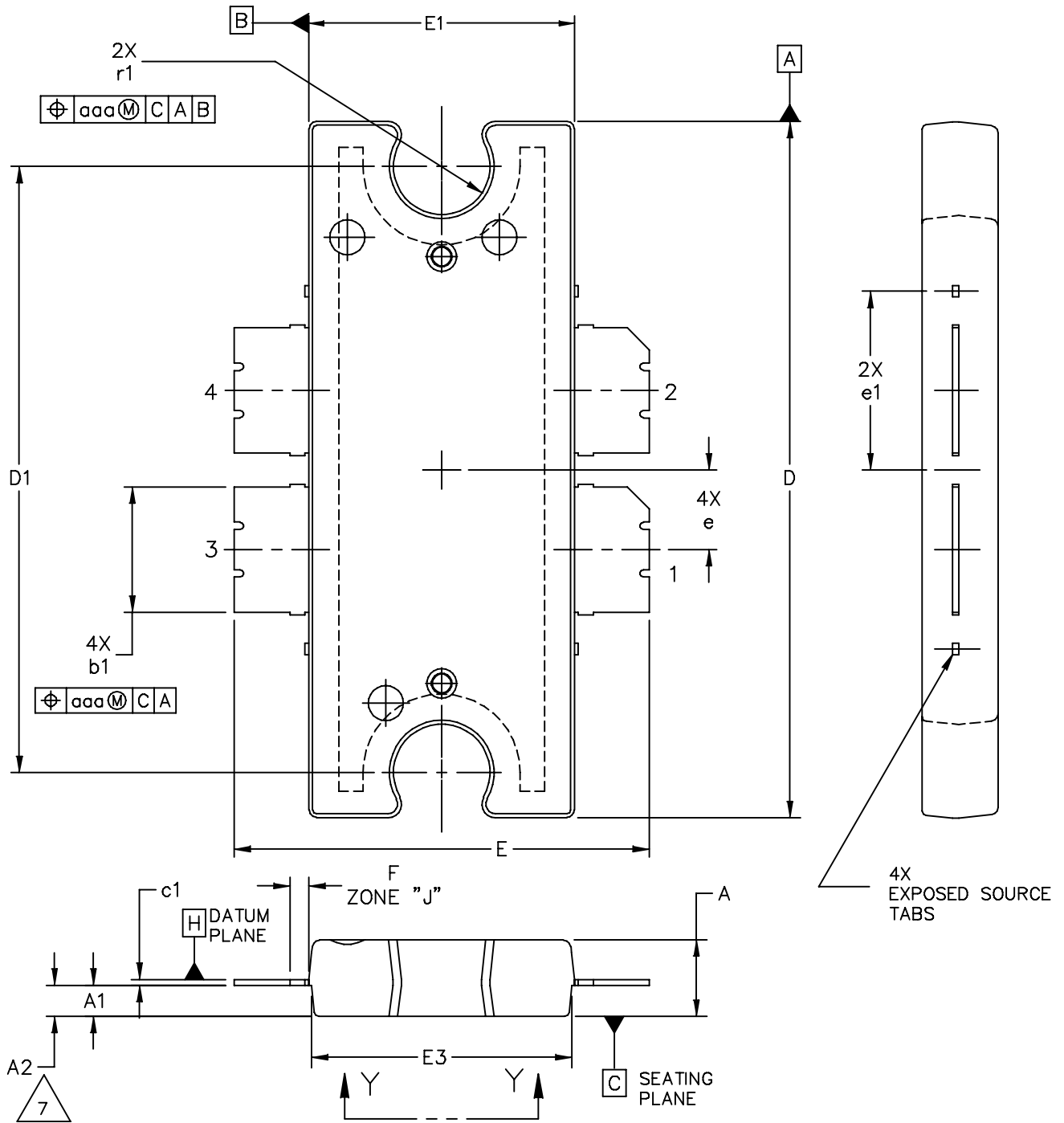

© FREESCALE SEMICONDUCTOR, INC. ALL RIGHTS RESERVED.		MECHANICAL OUTLINE		PRINT VERSION NOT TO SCALE	
TITLE: TO-272 4 LEAD, WIDE BODY			DOCUMENT NO: 98ASA10575D		REV: E
			CASE NUMBER: 1484-04		31 AUG 2007
			STANDARD: NON-JEDEC		

MRF6S18100NR1 MRF6S18100NBR1

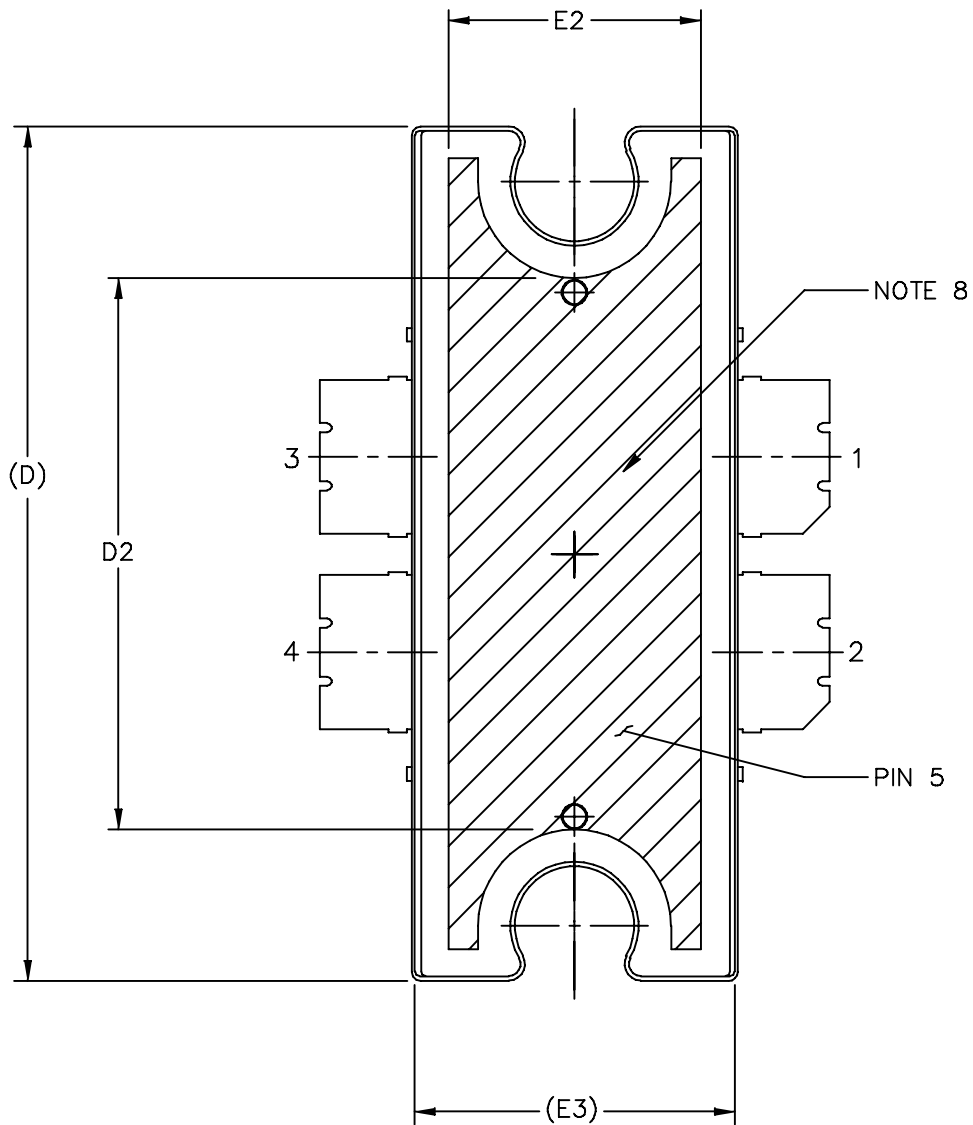

© FREESCALE SEMICONDUCTOR, INC. ALL RIGHTS RESERVED.	MECHANICAL OUTLINE	PRINT VERSION NOT TO SCALE	
TITLE: TO-272 4 LEAD, WIDE BODY	DOCUMENT NO: 98ASA10575D	REV: E	
	CASE NUMBER: 1484-04	31 AUG 2007	
	STANDARD: NON-JEDEC		

NOTES:

1. CONTROLLING DIMENSION: INCH
2. INTERPRET DIMENSIONS AND TOLERANCES PER ASME Y14.5M-1994.
3. DATUM PLANE H IS LOCATED AT THE TOP OF LEAD AND IS COINCIDENT WITH THE LEAD WHERE THE LEAD EXITS THE PLASTIC BODY AT THE TOP OF THE PARTING LINE.
4. DIMENSIONS "D" AND "E1" DO NOT INCLUDE MOLD PROTRUSION. ALLOWABLE PROTRUSION IS .006 PER SIDE. DIMENSIONS "D" AND "E1" DO INCLUDE MOLD MISMATCH AND ARE DETERMINED AT DATUM PLANE H.
5. DIMENSIONS "b1" DOES NOT INCLUDE DAMBAR PROTRUSION. ALLOWABLE DAMBAR PROTRUSION SHALL BE .005 TOTAL IN EXCESS OF THE "b1" DIMENSION AT MAXIMUM MATERIAL CONDITION.
6. DATUM A AND B TO BE DETERMINED AT DATUM PLANE H.
7. DIMENSION A2 APPLIES WITHIN ZONE "J" ONLY.
8. HATCHING REPRESENTS EXPOSED AREA OF THE HEAT SLUG. HATCHED AREA SHOWN IS ON THE SAME PLANE.

STYLE 1:

PIN 1 - DRAIN      PIN 2 - DRAIN  
 PIN 3 - GATE      PIN 4 - GATE  
 PIN 5 - SOURCE

DIM	INCH		MILLIMETER		DIM	INCH		MILLIMETER	
	MIN	MAX	MIN	MAX		MIN	MAX	MIN	MAX
A	.100	.104	2.54	2.64	b1	.164	.170	4.17	4.32
A1	.039	.043	0.99	1.09	c1	.007	.011	.18	.28
A2	.040	.042	1.02	1.07	r1	.063	.068	1.60	1.73
D	.928	.932	23.57	23.67	e	.106 BSC		2.69 BSC	
D1	.810 BSC		20.57 BSC		e1	.239 INFO ONLY		6.07 INFO ONLY	
D2	.600	---	15.24	---	aaa	.004		.10	
E	.551	.559	14	14.2					
E1	.353	.357	8.97	9.07					
E2	.270	---	6.86	---					
E3	.346	.350	8.79	8.89					
F	.025 BSC		0.64 BSC						

© FREESCALE SEMICONDUCTOR, INC. ALL RIGHTS RESERVED.		MECHANICAL OUTLINE		PRINT VERSION NOT TO SCALE	
TITLE:  TO-272 4 LEAD WIDE BODY			DOCUMENT NO: 98ASA10575D		REV: E
			CASE NUMBER: 1484-04		31 AUG 2007
			STANDARD: NON-JEDEC		

## PRODUCT DOCUMENTATION

Refer to the following documents to aid your design process.

### Application Notes

- AN1907: Solder Reflow Attach Method for High Power RF Devices in Plastic Packages
- AN1955: Thermal Measurement Methodology of RF Power Amplifiers
- AN3263: Bolt Down Mounting Method for High Power RF Transistors and RFICs in Over-Molded Plastic Packages

### Engineering Bulletins

- EB212: Using Data Sheet Impedances for RF LDMOS Devices

## REVISION HISTORY

The following table summarizes revisions to this document.

Revision	Date	Description
2	Dec. 2008	<ul style="list-style-type: none"> <li>• Modified data sheet to reflect RF Test Reduction described in Product and Process Change Notification number, PCN13232, p. 1, 2</li> <li>• Changed Storage Temperature Range in Max Ratings table from -65 to +175 to -65 to +150 for standardization across products, p. 1</li> <li>• Removed Total Device Dissipation from Max Ratings table as data was redundant (information already provided in Thermal Characteristics table), p. 1</li> <li>• Added Case Operating Temperature limit to the Maximum Ratings table and set limit to 150°C, p. 1</li> <li>• Operating Junction Temperature increased from 200°C to 225°C in Maximum Ratings table, related “Continuous use at maximum temperature will affect MTTF” footnote added and changed 200°C to 225°C in Capable Plastic Package bullet, p. 1</li> <li>• Corrected <math>V_{DS}</math> to <math>V_{DD}</math> in the RF test condition voltage callout for <math>V_{GS(Q)}</math>, On Characteristics table, p. 2</li> <li>• Removed Forward Transconductance from On Characteristics table as it no longer provided usable information, p. 2</li> <li>• Updated Part Numbers in Tables 6, 7, Component Designations and Values, to RoHS compliant part numbers, p. 3, 9</li> <li>• Removed lower voltage tests from Fig. 6, Power Gain versus Output Power, due to fixed tuned fixture limitations, p. 5</li> <li>• Replaced Fig. 13, MTTF versus Junction Temperature with updated graph. Removed Amps<sup>2</sup> and listed operating characteristics and location of MTTF calculator for device, p. 7</li> <li>• Replaced Case Outline 1486-03, Issue C, with 1486-03, Issue D, p. 14-16. Added pin numbers 1 through 4 on Sheet 1.</li> <li>• Replaced Case Outline 1484-04, Issue D, with 1484-04, Issue E, p. 17-19. Added pin numbers 1 through 4 on Sheet 1, replacing Gate and Drain notations with Pin 1 and Pin 2 designations.</li> <li>• Added Product Documentation and Revision History, p. 20</li> </ul>

LIFETIME BUY

LAST ORDER 1 JUL 11 LAST SHIP 30 JUN 12

## **How to Reach Us:**

### **Home Page:**

[www.freescale.com](http://www.freescale.com)

### **Web Support:**

<http://www.freescale.com/support>

### **USA/Europe or Locations Not Listed:**

Freescale Semiconductor, Inc.  
Technical Information Center, EL516  
2100 East Elliot Road  
Tempe, Arizona 85284  
1-800-521-6274 or +1-480-768-2130  
[www.freescale.com/support](http://www.freescale.com/support)

### **Europe, Middle East, and Africa:**

Freescale Halbleiter Deutschland GmbH  
Technical Information Center  
Schatzbogen 7  
81829 Muenchen, Germany  
+44 1296 380 456 (English)  
+46 8 52200080 (English)  
+49 89 92103 559 (German)  
+33 1 69 35 48 48 (French)  
[www.freescale.com/support](http://www.freescale.com/support)

### **Japan:**

Freescale Semiconductor Japan Ltd.  
Headquarters  
ARCO Tower 15F  
1-8-1, Shimo-Meguro, Meguro-ku,  
Tokyo 153-0064  
Japan  
0120 191014 or +81 3 5437 9125  
[support.japan@freescale.com](mailto:support.japan@freescale.com)

### **Asia/Pacific:**

Freescale Semiconductor China Ltd.  
Exchange Building 23F  
No. 118 Jianguo Road  
Chaoyang District  
Beijing 100022  
China  
+86 10 5879 8000  
[support.asia@freescale.com](mailto:support.asia@freescale.com)

### **For Literature Requests Only:**

Freescale Semiconductor Literature Distribution Center  
P.O. Box 5405  
Denver, Colorado 80217  
1-800-441-2447 or +1-303-675-2140  
Fax: +1-303-675-2150  
[LDCForFreescaleSemiconductor@hibbertgroup.com](mailto:LDCForFreescaleSemiconductor@hibbertgroup.com)

Information in this document is provided solely to enable system and software implementers to use Freescale Semiconductor products. There are no express or implied copyright licenses granted hereunder to design or fabricate any integrated circuits or integrated circuits based on the information in this document.

Freescale Semiconductor reserves the right to make changes without further notice to any products herein. Freescale Semiconductor makes no warranty, representation or guarantee regarding the suitability of its products for any particular purpose, nor does Freescale Semiconductor assume any liability arising out of the application or use of any product or circuit, and specifically disclaims any and all liability, including without limitation consequential or incidental damages. "Typical" parameters that may be provided in Freescale Semiconductor data sheets and/or specifications can and do vary in different applications and actual performance may vary over time. All operating parameters, including "Typicals", must be validated for each customer application by customer's technical experts. Freescale Semiconductor does not convey any license under its patent rights nor the rights of others. Freescale Semiconductor products are not designed, intended, or authorized for use as components in systems intended for surgical implant into the body, or other applications intended to support or sustain life, or for any other application in which the failure of the Freescale Semiconductor product could create a situation where personal injury or death may occur. Should Buyer purchase or use Freescale Semiconductor products for any such unintended or unauthorized application, Buyer shall indemnify and hold Freescale Semiconductor and its officers, employees, subsidiaries, affiliates, and distributors harmless against all claims, costs, damages, and expenses, and reasonable attorney fees arising out of, directly or indirectly, any claim of personal injury or death associated with such unintended or unauthorized use, even if such claim alleges that Freescale Semiconductor was negligent regarding the design or manufacture of the part.

Freescale™ and the Freescale logo are trademarks of Freescale Semiconductor, Inc. All other product or service names are the property of their respective owners.

© Freescale Semiconductor, Inc. 2005-2006, 2008. All rights reserved.

